

SE 120 LSNi SmartKey Arming Device



Security Systems

EN | Installation Manual
SE 120 LSNi



BOSCH

Table of Contents

Chapter	Page
System Description	
System Overview	3
Description of the Connections on the Control Unit.....	4
Installation Instructions	
Installing System Components.....	6
Installing the Magnetic Contact and Bolt Contact	7
Connecting the Control Panel and Optional Components	8
Connecting for Operation without an SPE Blocking Element	9
Function Test for the SPE Blocking Element and Reader	10
Reading In Keys and Programming the System	11
Concluding System Installation	16
Operating the System	
Viewing the System Status	17
Arming/Disarming.....	18
Example of Operation with 4 SmartKeys	19
Disarming for "Forced Unlocking and Alarm Display"	19
Fault Elimination	
Problems with Installation and Reading In Keys.....	20
Diagnosis Options on the Open Control Unit.....	20
Operating Problems During Normal Operation.....	21
Replacing the Bolt in the SPE Blocking Element.....	22
Notes for Maintenance and Service	
General.....	23
Inspection and Maintenance	23
Loss of Keys.....	24
Loss of the Security Card.....	24
Ordering Additional Keys	25
Restoring the Default Settings	25
Technical Data	26

System Overview

The SE 120 LSNi SmartKey arming device is a system solution for arming intrusion systems. The individual components of the system can be put together as required for the intended usage. Operating modes with or without the SPE blocking element are possible. Control authorizations for arming/disarming are defined during control panel programming.

SPE blocking element

The SPE blocking element is an additional lock for the door and is meant to prevent unauthorized entry to the armed area. The SPE blocking element is always installed in the armed area in conjunction with a kit to enable it to accommodate different doors (the image shows a door-mounted installation; for other variants, please see installing the SPE blocking element). A conventional magnetic contact can be used with the door-mounted installation kit. Operation types with and without blocking elements are possible.

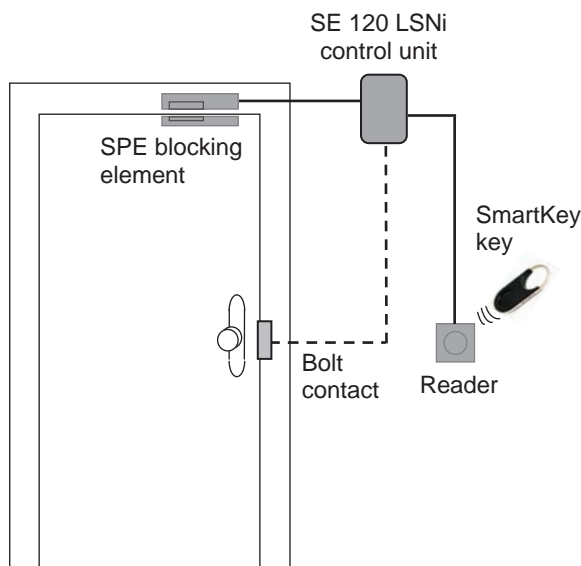

SE 120 LSNi control unit

The control unit processes the status reports of all components in the system, communicates these reports to the intrusion alarm system and controls the SPE blocking element. The control unit is installed in the secure area.

Reader

The system is armed and disarmed by holding an electronic key up to the reader. The LED and buzzer provide information about the status of the system as well as operation.

The reader can be surface mounted or recessed mounted (outside the secure area).

Bolt contact

A conventional bolt contact can be connected to the control unit. The bolt contact is not included in the scope of delivery.

Magnetic contact

A conventional standard magnetic contact can be connected to the control unit. The magnetic contact is not included in the scope of delivery.

Note: Conventional contacts are the recommended contact type as they can be processed directly by the control unit.

SmartKeys

There are two types of SmartKeys

- Keys with a security card
- Standard key (without security card)

Key with security card: the system operates like a locking device. The key kit consists of a set number of valid keys and a security card. The control unit is initialized using the security card and accepts only the keys of the key kit. To order additional keys, the security card must be sent to the manufacturer together with the order. The keys are labeled with a consecutive key number, a security card number and an 8-digit identification number.

Standard key (without security card): the keys are not numbered and can be read in as often as required. The keys are labeled with an 8-digit identification number.

System Description

Description of the Connections on the Control Unit

The control unit connections have different functions. There are inputs, outputs and plug-in terminals. Inputs and outputs have to be assigned according to a specific schema with regard to the scope of basic functions.

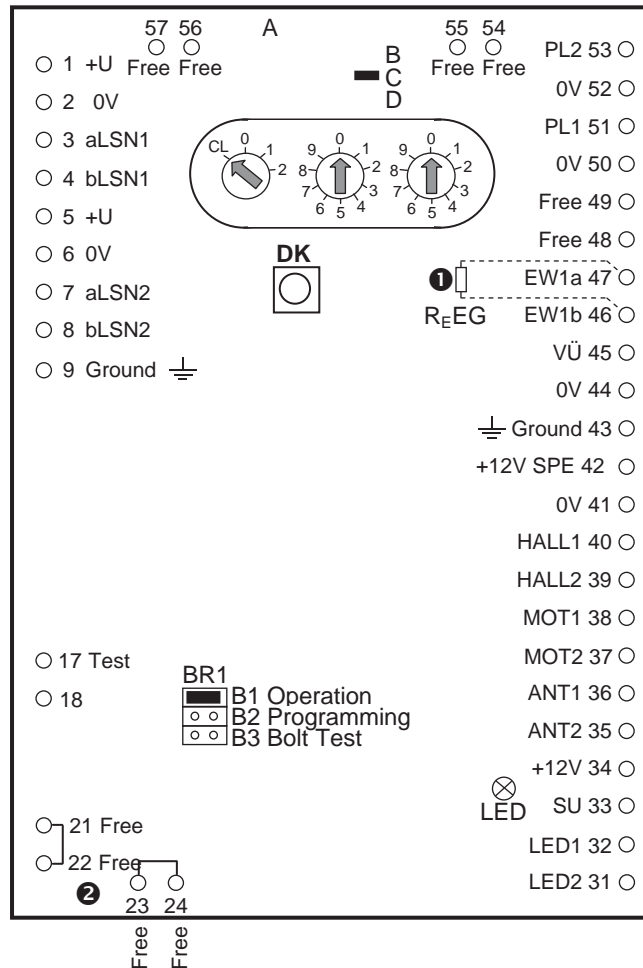

① R_EEG 12K1 already installed

② Points 21/22 and 23/24 are connected internally.

System Description

Description of the Connections on the Control Unit

Connection	Name	Function	Description
1	+ U	Input	Power supply 9.6 - 30V
2	0V	Input	Power supply 0V
3	aLSN1	Input	LSN incoming
4	bLSN1	Input	LSN incoming
5	+ U	Output	Power supply 9.6 - 30V
6	0V	Output	Power supply 0V
7	aLSN2	Output	LSN outgoing
8	bLSN2	Output	LSN outgoing
9	Ground	Distributor	Operating ground
17	Test	Input	This input is for test purposes only, i.e. a line should only be connected temporarily to perform a test. The SPE blocking element's bolt will engage when 0V is connected.
18			N.A.
21/22	Free	Distributor	Free plug-in terminals, 21 and 22 connected
23/24	Free	Distributor	Free plug-in terminals, 23 and 24 connected
31	LED 2	Output	Green LED reader
32	LED 1	Output	Red LED reader
33	SU	Output	Buzzer reader
34	+12V	Output	Power supply 12V reader
35/36	ANT2/ANT1	Input	Antenna reader
37/38	MOT2/MOT1	Output	SPE blocking element motor control
39	HALL2	Input	Detection of initial bolt position
40	HALL1	Input	Detection of final bolt position
41	0V	Output	Power supply 0V for SPE blocking element
42	+ U	Output	Power supply 12V for SPE blocking element
43	Ground	Distributor	Operating ground
44/45	0V/VÜ	Input	Connection option for conventional bolt contact
46/47	EW1b/EW1a	Input	Connection option for magnetic contact
50/51	0V/PL 1	Input	Connection option for magnetic contact
			<p style="text-align: center;">Conventional magnetic contact</p>
48/49	Free	Distributor	Free plug-in terminals
52/53	0V/PL 2	Input	Primary line that can be used freely
54 - 57	Free	Distributor	Free plug-in terminals

Note: The primary lines PL 1, PL 2 and VÜ are evaluated by the control unit.

Installation Instructions

Installing System Components

Note the following during installation:



- Used shielded cables only.
- The usual precautionary measures for handling C-MOS technology apply to handling the circuit boards and to soldering work. Wear a grounded wrist strap when working on the control panel.

Mounting the control unit

- Mount the control unit to the wall. When choosing a position to mount the unit,



please note that the reader and the SPE blocking element are equipped with a 6 m molded cable that must not be lengthened.

Installing the reader

- Install the reader according to the enclosed installation notes.



If you are installing the reader close to other systems with proximity scanners, please make sure that a distance to these systems of at least 0.5 m is maintained.

The installation height should be at least 1.2 m and preferably recessed mounted. The reader is molded and completely resistant to environmental influence. Do not fit the reader cover until you have performed all the function tests. Removing the cover after it has been fitted will cause damage to the cover. The reader is equipped with a 6 m molded cable that must not be lengthened.

Installation Instructions

Installing System Components

Installing the SPE blocking element

- Install the SPE blocking element using the appropriate kit and in accordance with the enclosed installation notes.



Make sure the door cannot slam shut. The bolt on the SPE blocking element could otherwise be damaged during start-up by a slamming door.

SPE blocking element variants and kits

Installation on the door or on the frame

Kit for on-the-door installation. In the kit, a conventional magnet contact can be used.

Bolt piece (installed on the frame)

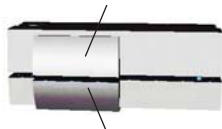

Sleeve piece (installed on the door)

Kit for glass doors

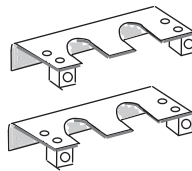

Installation on the door or on the frame

Bushing



Normal collar



Angled collar



Counterpiece



Installation example:

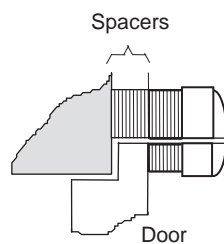

Installation example:

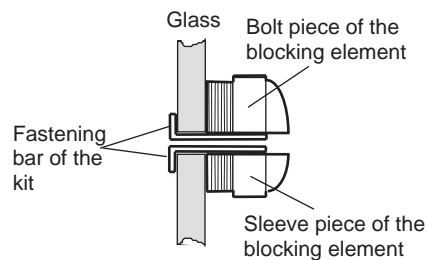

Installation example:

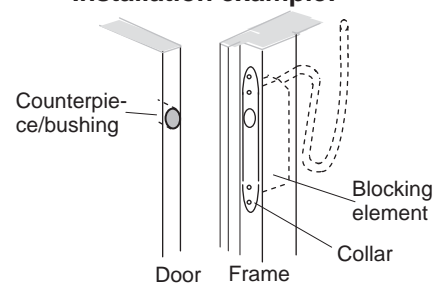

Installing the Magnetic Contact and Bolt Contact

Install the magnetic contact or bolt contact in accordance with the manufacturer's instructions. The control unit will serve as a distributor for the contacts.

Installation Instructions

Connecting the Control Panel and Optional Components



Make sure the control panel is disconnected from the power supply.

Connect the control unit and the optional components as shown in the connection diagram on the following page.

Address switch: The address switch is used for LSN control panels in the planning stage. The address switch does not need to be adjusted on any of the currently available LSN control panels. The address switch should remain in the positions CL 0 0. Default setting.

Preliminary information on the address switch:

- CL 0 0 = "Classic" LSN mode (standard setting)
- 001 – 254 = LSNi mode with manual addressing of the control unit
- 0 0 0 = LSNi mode with automatic addressing of the control unit

The control unit address is set by positioning the three rotatable switches. Use a flat-head screwdriver to adjust each switch. The switches will click when turned. The valid range is from 1 to 254. Any setting between 255 and 299 will cause an error message to be displayed on the control panel.

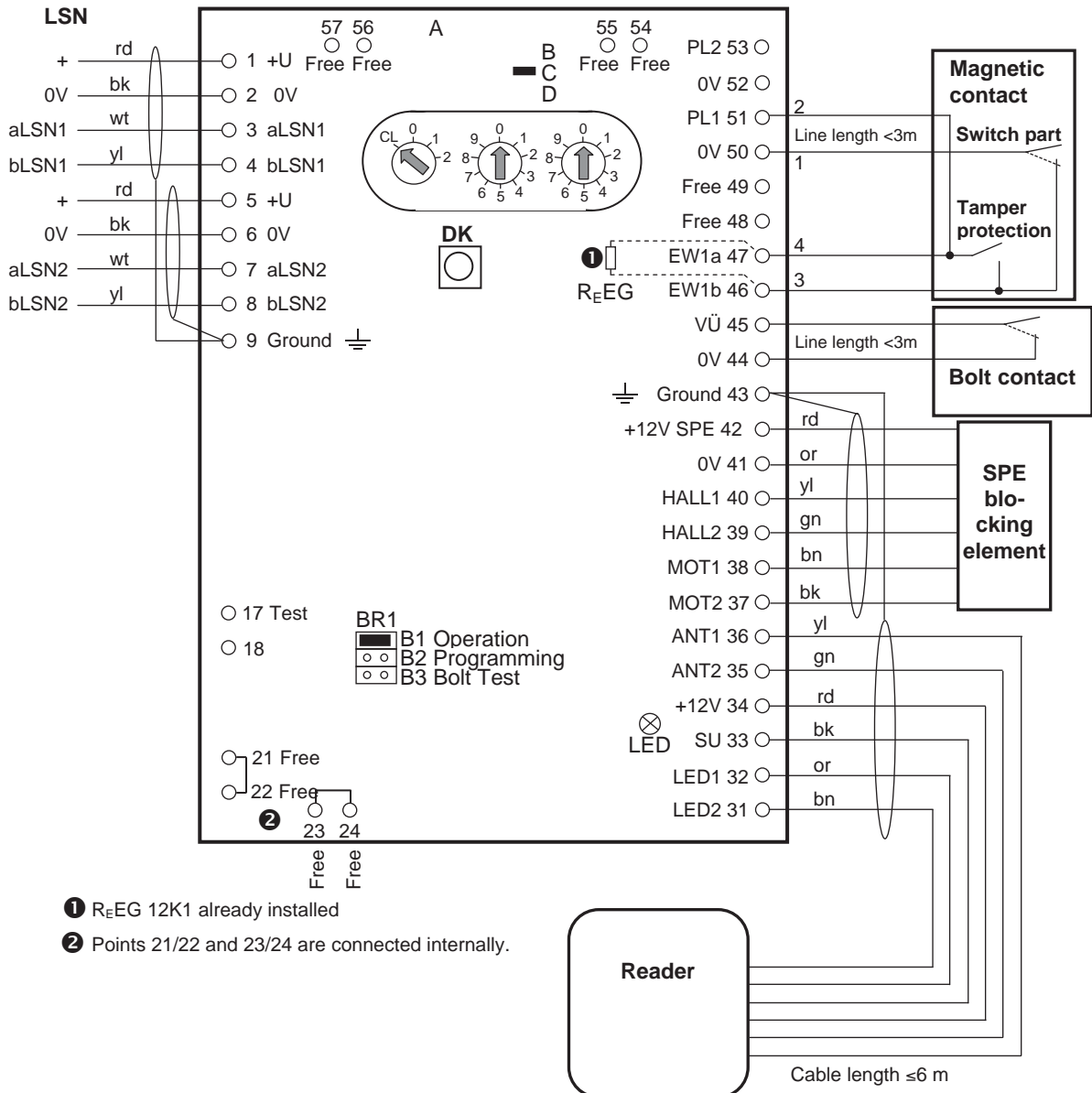

Installation Instructions

Connecting for Operation Without an SPE Blocking Element

Use the following switching arrangement on the control unit to set the operating mode without SPE blocking element. Connect the inputs HALL1 and HALL2 to 0V.

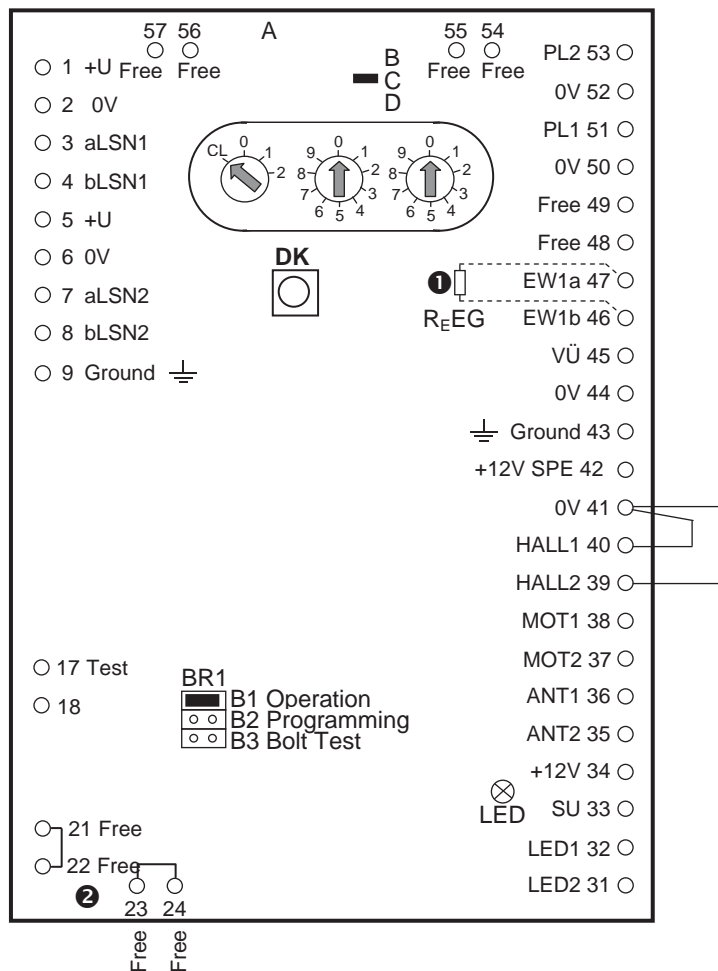

① REEG 12K1 already installed

② Points 21/22 and 23/24 are connected internally.

Installation Instructions

Function Test for the SPE Blocking Element and Reader

Turning on the power supply

- Make sure that bridge B1 on the control unit is connected before turning on the power supply.
- Turn on the power supply.

The yellow LED on the control unit displays the system's status as follows:

Yellow LED	Status	Required action
Off	System is OK	None
On	Electronic defect.	Turn the power supply off and then back on. Replace the control unit if the LED is still activated.

Function test

1. Remove the jumper from B1 and connect it to B3 on the control unit.
 - ➔ The SPE blocking element bolt engages. The yellow LED on the control unit lights up. The red and green LEDs on the reader light up. The reader buzzer sounds for 5 seconds.
2. Remove the jumper from B3 on the control unit.
 - ➔ The SPE blocking element bolt disengages. The LEDs on the control unit and the reader are go out.
3. Repeat steps 1 - 2 with the door closed to check the precise insertion of the SPE blocking element's bolt into the bolt-hole.
4. Reconnect the jumper to bridge B1 on the control unit once you have completed the function test.

The yellow LED on the control unit's circuit board displays the system's status as follows:

LED	Status	Required action
Off	System is OK	None
1 flash	Bolt will not engage or disengage.	<ul style="list-style-type: none">▪ Check that the SPE blocking element and the bolt-hole are correctly installed and connected to the power supply.▪ Repeat the test.

Reading In Keys and Programming the System

Depending on the "key type" and "reading in method of the key", perform **one** of the following 4 steps. Reading in keys as described under points 2 and 4 should only be used in exceptional circumstances. You will find the description on the following pages.

1. Key **with** security card: Reading in keys during **programming** (see point 1).
2. Key **with** security card: Reading in keys via the **reader** (see point 2).
3. Standard key (**without** security card): Reading in keys during **programming** (see point 3).
4. Standard key (**without** security card): Reading in keys via the **reader** (see point 4).

Key (with a security card)

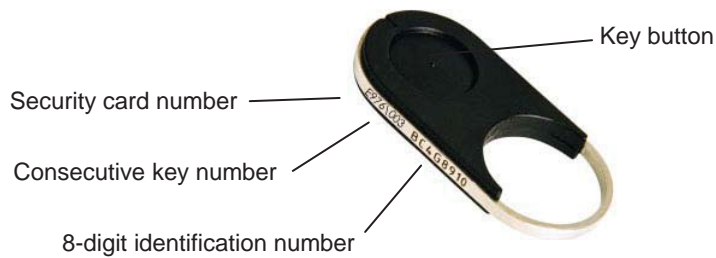

Standard key (without security card)

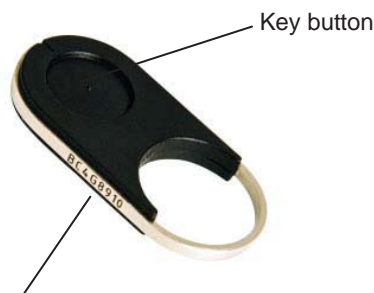

The standard key is labeled with the 8-digit identification number only.

Installation Instructions

1. Key with security card: Reading in keys during programming

Programming the SE 120 LSNi system and reading in the key identification number is carried out with the appropriate programming program (e.g. WinPara or NzPara). This is when the key's 8-digit identification number is entered into the system. In the programming program, select for the keys to be read in during programming (select the parameter "**integrated**" for SE 120 when using NzPara). The maximum number of keys depends on the control panel in use.

Reading in occurs in two stages. First, the security card is read in. Reading in the security card at the reader replaces the manufacturer's general works code with the individual customer code. This is followed by programming and the 8-digit identification numbers of the keys are entered.

Operation sequence:

1.  The plugs with the LSN lines (3.4 and 7.8) must be removed from the control unit. The control panel will display an LSN line malfunction message.
2. Connect the jumper on the control unit's circuit board to bridge B2.

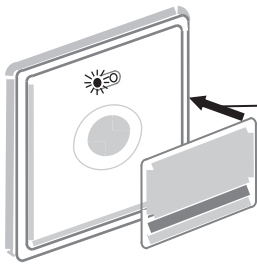

3. Hold the front **or** the reverse side of the security card parallel to the reader at a maximum distance of 2 cm until the red LED lights up.
➔ This completes reading in the security card.

4. Connect the jumper back to B1.
➔ The yellow LED on the control unit and the red LED on the reader go out.
5. Reconnect the plugs with the LSN lines to the control unit and reset the LSN line malfunction message on the control panel.
6. In the programming program, select for the keys to be read in during programming (select the parameter "**integrated**" for SE 120 when using NzPara). Enter the keys' 8-digit identification number into the programming program and program the control panel.
➔ This completes programming the keys.

Installation Instructions

2. Key with security card: Reading in keys via the reader

Keys (maximum 16) can be read in directly via the reader if the 8-digit identification number is not entered during programming. In the programming program (e.g. WinPara or NzPara), select for the keys to be read in via the reader (select the parameter "**standalone**" for SE 120 when using NzPara). The control panel must be programmed before the keys are read in.

Reading in occurs in two stages. First, the security card is read in, then the keys. Reading in the security card at the reader replaces the manufacturer's general works code with the individual customer code.

Operation sequence:

1. Programming has been concluded with the appropriate settings (see also above).
2.  The plugs with the LSN lines (3.4 and 7.8) must be removed from the control unit. The control panel will display an LSN line malfunction message.

3. Connect the jumper on the control unit's circuit board to bridge B2.

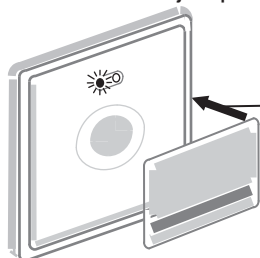

4. Hold the front **or** the reverse side of the security card parallel to the reader at a maximum distance of 2 cm until the red LED lights up.

➔ This completes reading in the security card.

5. Press and hold the key button and hold the first key up to the circle on the center of the reader at a maximum distance of 2 cm until you hear a short confirmation signal.

6. Repeat step 5 for all the other keys. The flashing signals of the control unit's yellow LED and the red LED on the reader correspond with the number of keys.

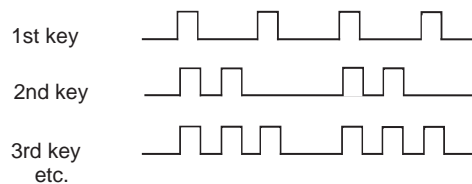

7. Connect the jumper back to B1.
➔ The yellow LED on the control unit and the red LED on the reader go out. This completes programming the keys.
8. Reconnect the plugs with the LSN lines to the control unit and reset the LSN line malfunction message on the control panel.

Installation Instructions

3. Standard key (without security card): Reading in keys during programming

Programming the SE 120 LSNi system and reading in the key identification number is carried out with the appropriate programming program (e.g. WinPara or NzPara). This is when the key's 8-digit identification number is entered into the system. In the programming program, select for the keys to be read in during programming (select the parameter "**integrated**" for SE 120 when using NzPara). The maximum number of keys depends on the control panel in use.

Reading in occurs in two stages. First, any standard key on the reader is read in. This replaces the manufacturer's general works code with the code of the standard key. Following this, programming is carried out with the entry of the 8-digit identification numbers of the keys.

Operation sequence:

1.  The plugs with the LSN lines (3.4 and 7.8) must be removed from the control unit. The control panel will display an LSN line malfunction message.
2. Connect the jumper on the control unit's circuit board to bridge B2.

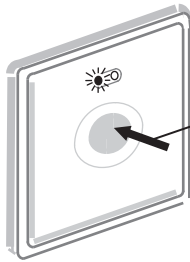

3. Press and hold the key button and hold any standard key up to the reader at a maximum distance of 2 cm until the red LED lights up.
➔ This concludes reading in the standard key's code.

4. Connect the jumper back to B1.
➔ The yellow LED on the control unit and the red LED on the reader go out.
5. Reconnect the plugs with the LSN lines to the control unit and reset the LSN line malfunction message on the control panel.
6. In the programming program, select for the keys to be read in during programming (select the parameter "**integrated**" for SE 120 when using NzPara). Enter the keys' 8-digit identification number into the programming program and program the control panel.
➔ This completes programming the keys.

Installation Instructions

4. Standard key (without security card): Reading in keys via the reader

Keys (maximum 16) can be read in directly via the reader if the 8-digit identification number is not entered during programming. In the programming program (e.g. WinPara or NzPara), select for the keys to be read in via the reader (select the parameter "**standalone**" for SE 120 when using NzPara). The control panel must be programmed before the keys are read in.

Reading the standard key into the reader replaces the manufacturer's standard works code with the standard key's code.

Operation sequence:

1.  The plugs with the LSN lines (3.4 and 7.8) must be removed from the control unit. The control panel will display an LSN line malfunction message.
2. Connect the jumper on the control unit's circuit board to bridge B2.

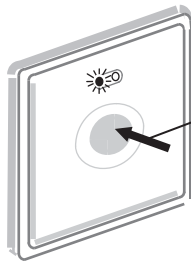

3. Press and hold the key button and hold any standard key up to the circle on the center of the reader at a maximum distance of 2 cm until the red LED flashes and you hear two short confirmation signals.

4. Press and hold the key button and hold the remaining keys up to the circle on the center of the reader at a maximum distance of 2 cm until you hear a short confirmation signal.

The flashing signals of the control unit's yellow LED and the red LED on the reader correspond with the number of keys.

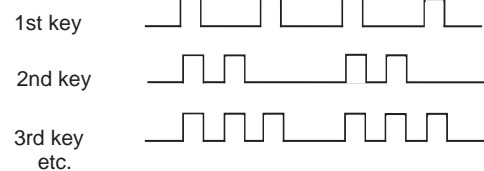

5. Connect the jumper back to B1.
 - ➔ The yellow LED on the control unit and the red LED on the reader go out. This completes programming the keys.
6. Reconnect the plugs with the LSN lines to the control unit and reset the LSN line malfunction message on the control panel.

Installation Instructions

Concluding System Installation

1. Make sure that bridge B1 on the control unit is closed for normal operation. Replace the control unit cover.
2. Make sure the red and green LEDs on the reader are off (= normal operating condition).
3. Arm and then disarm each key (see following chapter) to make sure that the programming is correct. Inform the operator of this step in advance to avoid any unnecessary interruption of operations.

Note: The bolt will engage when the bolt contact is closed.

Viewing the System Status

- Press and hold the key button and hold the key up to the reader for 1 second. The system status is indicated as shown in the following table.

Display element	Behavior	Meaning
Green LED	Lit	System disarmed
	Flashing	System is attempting to disarm
Red LED	Lit	System is armed
	Flashing	System is attempting to arm
Buzzer	Short signal for 0.5 sec.	Process initiated
	Short signal for 2.5 sec.	Process completed successfully
	Interval signal for 5 sec.	Process not completed successfully

Operating the System

Arming

1. Press and hold the key button and hold the key up to the reader for 3 seconds until you hear a short signal from the buzzer.

- ➔ The green LED is activated, signaling that the system is currently disarmed.
- ➔ The red LED starts to flash, signaling that the arming process has commenced.

Further reader signals (LED) follow as described in the left-hand box (arming successful) or in the right-hand box (arming unsuccessful).

- ➔ The green LED is deactivated.
- ➔ The red LED and the buzzer are activated for 2.5 seconds (continuous signal).

System arming successful.

- ➔ The red LED is deactivated.
- ➔ The green LED lights up for 5 seconds.
- ➔ The buzzer simultaneously emits an interval signal for 5 seconds.

System arming unsuccessful. See the table "Operating Problems During Normal Operation" for assistance.

Disarming

1. Press and hold the key button and hold the key up to the reader for 3 seconds until you hear a short signal from the buzzer.

- ➔ The red LED is activated, signaling that the system is currently armed.
- ➔ The green LED starts to flash, signaling that the disarming process has commenced.

Further reader signals (LED) follow as described in the left-hand box (disarming successful) or in the right-hand box (disarming unsuccessful).

- ➔ The red LED is deactivated.
- ➔ The green LED and the buzzer are activated for 2.5 seconds (continuous signal).

Disarming was successful.

- ➔ The green LED is deactivated.
- ➔ The red LED is activated for 5 seconds.
- ➔ The buzzer simultaneously emits an interval signal for 5 seconds.

Disarming was unsuccessful. See the table "Operating Problems During Normal Operation" for assistance.

Example of Operation with 4 SmartKeys

All SmartKeys have equal arming and disarming rights.

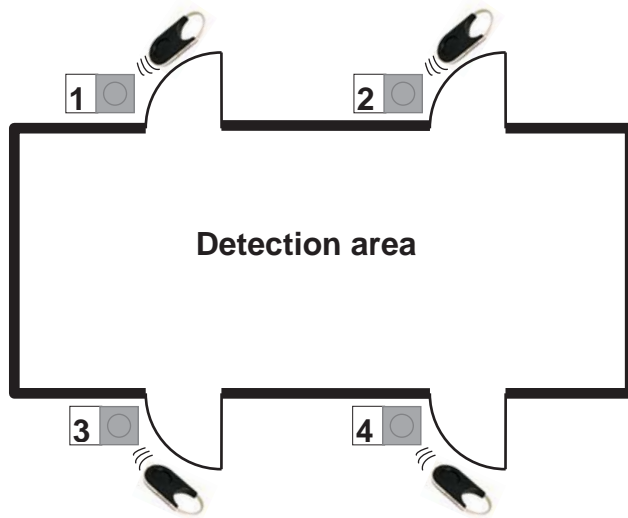

Arming:

Arming can occur with any SmartKey once all the bolt contacts are closed and the detection area is ready to be activated. Arming will engage all SPE blocking element bolts.

Disarming:

Any SmartKey can be used for disarming. Disarming will disengage all SPE blocking element bolts.

Viewing the system status and the procedures for arming/disarming are the same as described on the two previous pages.

Disarming for "Forced Unlocking and Alarm Display"



The operator's attention must be drawn to the following points if this function has been programmed in the EMA.

If the red LED on the reader flashes continuously after disarming, it means that the SmartKey is signaling an intrusion alarm. It is recommendable to have a procedure in place to protect the operator, e.g.: do not enter the area; call the alarm company or the police etc. The red LED will be deactivated when the intrusion alarm system is reset.

If programmed, this function will immediately retract the SPE blocking element bolt when an external alarm is triggered and an optical signal (flashing red LED) will indicate this status to the user when the external alarm is disarmed.

Fault Elimination

Problems with Installation and Reading In Keys

Always check the following first of all:

- Are the component cables correctly connected?
- Are there any short-circuits/broken wires?
- Is the component connected to a power supply?
- Is bridge BR1 correctly connected to control unit?

Problem	Possible cause(s)	Elimination
LEDs on the reader/control unit are not activated during function test.	Component damaged (through transport, incorrect handling etc).	Component needs replacing.
Bolt does not engage/disengage during function test.	<ul style="list-style-type: none"> ▪ Installation error ▪ SPE blocking element damaged 	Check the installation and fitting of SPE blocking element and repeat the test. Replace the SPE blocking element if this proves unsuccessful.
Five second interval tones are emitted when keys are read in (only when the keys are read in directly via the reader).	Max. permissible number of key (16) exceeded. (for "standalone" operating mode).	Check the correct number of keys.

Diagnosis Options on the Open Control Unit

Yellow LED	Status	Required action
Off	System is OK	None
On	Electronic defect.	Turn the power supply off and then back on. Replace the control unit if the LED is still activated.
1 flash	<ul style="list-style-type: none"> ▪ Bolt will not engage ▪ Bolt engages but does not recognize the end position. 	Check the SPE blocking element and the bolt-hole for correct installation.
2 flashes	Antenna malfunction	<ul style="list-style-type: none"> ▪ Check that the reader is correctly connected. ▪ Switch the power supply off and then back on. Replace the reader if the LED continues to flash.

Operating Problems During Normal Operation

Problem	Possible cause(s)	Elimination
Reader does not respond when the key is held up to the scanner.	<ul style="list-style-type: none"> ▪ Key outside of scanner range. ▪ Key not held up to the reader for long enough. ▪ Key button not pressed when key was held up to the reader. ▪ Metal objects located between key and reader. 	Repeat the arming process after removing any of the possible causes of error.
No display on the reader, only an interval signal when the key is held up to the scanner.	<ul style="list-style-type: none"> ▪ Key not/incorrectly programmed or read in. ▪ Key bypassed by security manager. 	Check possible causes of error or inform your security manager.
Area cannot be armed. Interval signal is sounded immediately after the system status is displayed on the reader.	<ul style="list-style-type: none"> ▪ Open bolt or magnetic contact on the SmartKey door. ▪ User not authorized to arm the area. 	Repeat the arming process after removing any of the possible causes of error.
Area cannot be armed. Interval signal sounds for approx. 15 seconds after arming was requested (= red LED flashes).	<ul style="list-style-type: none"> ▪ Locking bolt does not engage properly. ▪ Open doors or windows in the detection area. ▪ In the case of multiple detection areas: arming sequence not adhered to. ▪ If detection area has a block type lock: block type lock not locked. 	Repeat the arming process after removing any of the possible causes of error.
Area cannot be disarmed. Interval signal is sounded immediately after the system status is displayed on the reader.	<ul style="list-style-type: none"> ▪ User not authorized to arm the area. ▪ User temporarily unauthorized to arm the area because he belongs to a specific time group. 	Repeat the arming process after removing any of the possible causes of errors.
Area cannot be disarmed. Interval signal sounds for approx. 15 seconds after disarming was requested (= green LED flashes).	<ul style="list-style-type: none"> ▪ In the case of multiple detection areas: arming sequence not adhered to. ▪ Additional coded arming device (e.g. timer locks) preventing system from disarming. 	Repeat the arming process after removing any of the possible causes of errors.
Door will not open despite correct disarming procedure.	<ul style="list-style-type: none"> ▪ Bolt is stuck (door could be slightly warped). 	Gently jolt the door, then arm and disarm the system. If this is unsuccessful the door will have to be pushed/pulled open with force (pre-determined breaking point in the SPE blocking element will break, the door remains undamaged).

Fault Elimination

Replacing the Bolt in the SPE Blocking Element

(for instance, if the bolt is broken or cannot be moved)

The bolt can be replaced while the system is running (disarmed state).

Consult the appropriate installation notes and proceed as follows:

1. Uncover the SPE blocking element by removing the plastic cover from the bolt part (for door-mounted installation) or the collar (built-in version). For door-mounted elements, the magnetic contact housing may also have to be removed.
2. Undo the screws on the SPE blocking element (1) and remove the cover.
3. Lift the motor screw (2) slightly to release the bolt (3) from the gear installation.
4. Extract the bolt.
5. Replace with a new bolt.
6. Replace the motor in its original position.
7. Replace the cover and tighten the screws.
8. Install the SPE blocking element according to the installation notes.

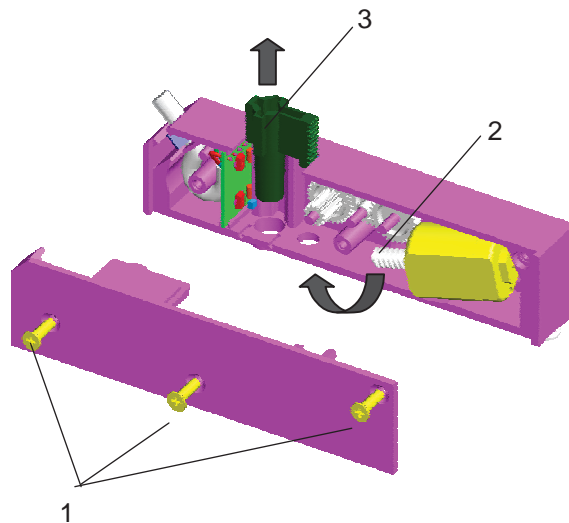

General

Maintenance and inspection measures must be performed at specific intervals by appropriately qualified personnel. Furthermore, the regulations of DIN VDE 0833 apply to all related work.

Inspection and Maintenance

- Function test of the control unit tamper contact function
- Visual inspection of installation/damage.
- Function test for the SPE blocking element

Function test for the SPE blocking element with bolt contact:

1. Activate the bolt contact when the door is closed.
 - ➔ The SPE blocking element bolt engages.
2. Place the bolt contact back on stand-by.
 - ➔ The SPE blocking element bolt disengages.

SPE blocking element function test with control unit (tamper contact open):

1. Remove the jumper from B1 and connect it to B3 on the control unit.
 - ➔ The SPE blocking element bolt engages.
 - ➔ The yellow LED on the control unit lights up.
2. Remove the jumper from B3 on the control unit.
 - ➔ The SPE blocking element bolt disengages.
 - ➔ The yellow LED on the control unit goes out.
3. Repeat steps 1 - 2 with the door closed to check the precise insertion of the SPE blocking element's bolt into the bolt-hole.
4. Reconnect the jumper to B1 on the control unit once you have completed the function test.

The yellow LED on the control unit's circuit board displays the system's status as follows:

Yellow LED	Status	Required action
Off	System is OK	None
1 flash	Bolt will not engage	<ul style="list-style-type: none">▪ Check that the SPE blocking element and the bolt-hole are correctly installed and connected to the power supply.▪ Repeat the test

Notes for Maintenance and Service

Loss of Keys

The following steps are required if the keys were read in **during programming**:

1. Bypass the key using the control panel keypad or erase the key using the appropriate programming program (e.g. WinPara or NzPara)
2. Order a new key.
 - see chapter "Ordering Additional Keys"

The following steps are required if the keys were read in **directly via the reader**:

1. For security reasons, erase all remaining keys and the individual customer code, i.e. restore the default settings
 - see chapter "Restoring the Default Settings"
2. Read in the security card or standard key and all the remaining keys from scratch
 - see chapter "Reading In Keys and Programming the System"
3. Order a new key.
 - see chapter "Ordering Additional Keys"

Loss of the Security Card

Losing the security card will not compromise system functionality. However, if at some stage in the future you need further keys you will have to request both a new security card **and** new keys from the manufacturer.

The following steps are required once you have received the new security card and keys:

1. Restore the default settings
 - see chapter "Restoring the Default Settings"
2. Read in the new security card and keys
 - see chapter "Reading In Keys and Programming the System"

Ordering Additional Keys

The following steps are required if you need new keys (e.g. for new members of staff):

Keys with a security card

- Send your order to the manufacturer together with the security card so that the new keys can be registered on the card.
- When you have received the additional keys, read them in as described in the chapter "Reading In Keys and Programming the System". You do **not** have to re-read in the security card (or customer card).

Standard key (without security card)

- Order additional standard keys.
- When you have received the key, read the standard key into the system as an additional key (see chapter "Reading In Keys and Programming the System").

Restoring the Default Settings

Restore the default settings as follows:

1. The system is in a disarmed state (e.g. in revision mode).
2.  Remove the control unit cover. The plugs with the LSN lines (3.4 and 7.8) must be removed from the control unit.
3. In the control unit, move the jumper from BR1 to BR2.
4. Close the tamper contact GK for at least 3 seconds until the yellow LED on the control unit is deactivated and the buzzer emits a signal.
 - ➡ All the keys and the customer code have now been erased.The default settings have been restored.
5. In the control unit, move the jumper from BR2 back to BR1.
6. Reconnect the plugs with the LSN lines to the control unit and reset the LSN line malfunction message on the control panel.

Technical Data

SE 120 LSNi control unit

Operating voltage	9.6 V...30 V
Total current consumption including blocking element at an input voltage of 9.6 V	
- Restore LSN part	3.53 mA
- Restore additional supply	41 mA
- Bolts being engaged	110 mA for 200 ms
- Bolts blocked	470 mA for 200 ms
Total current consumption including blocking element at an input voltage of 28 V	
- Restore LSN part	3.53 mA
- Restore additional supply	30 mA
- Bolts being engaged	65 mA for 200 ms
- Bolts blocked	200 mA for 200 ms
Environmental conditions	
- Environmental class	2
- Protective system	IP 30
- Operating temperature	-5°C...+45°C
- Storage temperature	-40°C...+85°C
Housing	
- Material	ABS
- Color	RAL 9002
Dimensions (WxHxD)	135 x 160 x 35 mm
Weight	0.25 Kg
VdS approval (Cl. C) for overall system	G 106063, C

Reader

Range	max. 20 mm
Frequency	125 kHz
Transmission power	250 mW
Cable to control unit	max. 6 m, 6-pin, screened, completely sealed
Environmental conditions	
- Environmental class	3
- Protective system	IP 65
- Operating temperature	-25°C...+70°C
- Storage temperature	-40°C...+85°C
Housing	
- Material	ASA Luran S
- Color	Titanium white (cp. RAL 9010)
Dimensions (WxHxD)	80 x 80 x 30 mm
For installation in 55 mm-surface-mount/recessed-mount junction boxes	
Weight	0.35 Kg

Blocking element

Max. distance between bolt and counterpiece	4 mm
Bolt break force	approx. 1kN
Cable to Control unit	max. 6 m, 6-pin, screened, completely sealed
Environmental conditions	
- Environmental class	3
- Protective system	IP 44
- Operating temperature	-25°C...+55°C
- Storage temperature	-40°C...+85°C
Housing	
- Material	ABS
- Color	RAL 9002
Weight	
- Surface mounted models	0.45 Kg
- Recessed mounted models	0.40 Kg
Dimensions (WxHxD)	118 x 28 x 16 mm

Note on the blocking element: SE 120 LSNi without bolt contact. If all the bolts of all SE 120 LSNi units in a detection area are to be activated simultaneously, the values for "activated bolts" must be added together when calculating power requirements. Up to four SE 120 LSNi can be activated within 200 ms due to the time shift caused by the LSN.



125 kHz
0.029 uW (-10 dBuA/m)

Key

Range	max. 20 mm
Environmental conditions	
- Environmental class	4
- Protective system	IP 67
- Operating temperature	-40°C...+70°C
- Storage temperature	-40°C...+85°C
Housing	
- Material	POM
- Color	RAL 9005 (black)
Dimensions (WxHxD)	27 x 24 x 6 mm
Weight	0.011 kg

Laws/Standards/Directives

The system fulfills all the requirements of the relevant laws, standards and directives, in particular those of

-
- EN 61000-6-3
 - EN 50130-4
 - DIN VDE 0833, Parts 1 and 3
 - VdS 2110
 - VdS 2227
 - VdS 2119
 - VdS 2311
 - VdS 2203
 - VdS 2252
-

Bosch Security Systems

For more information, please see the following web site

www.bosch-sicherheitssysteme.de

Bosch Sicherheitssysteme GmbH

Robert-Bosch-Ring 5

85630 Grasbrunn

Germany

F.01U.341.974

A2 04.2017



BOSCH