

RF3405E

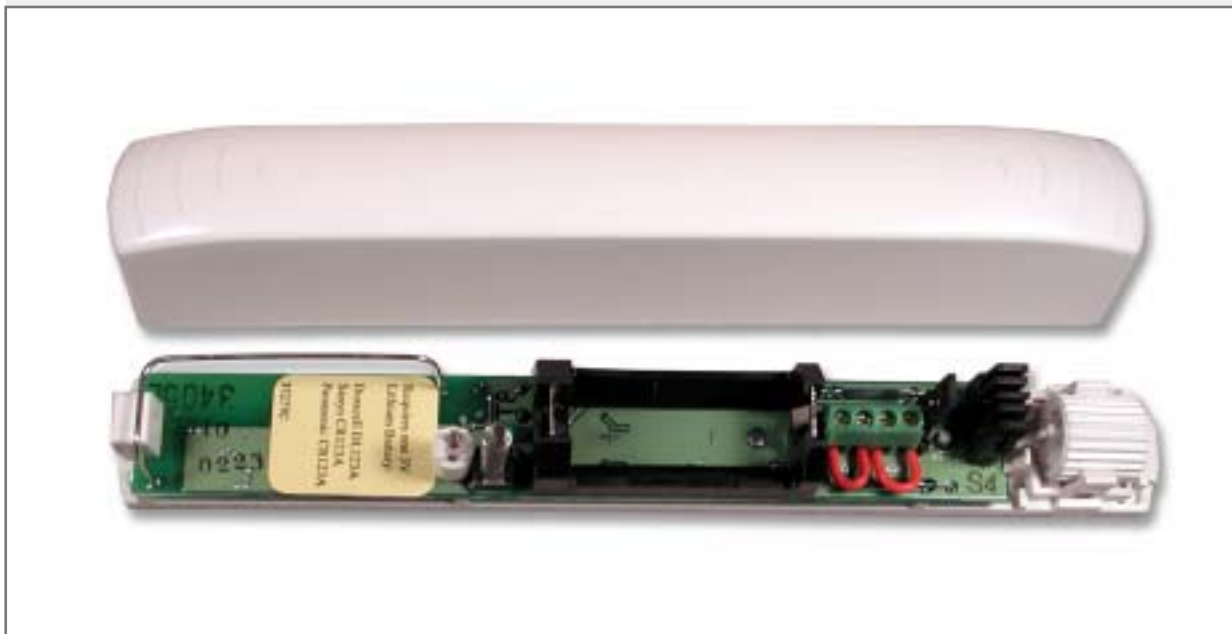

Security Systems

EN | Installation Instructions
Wireless (RF) Inertia
Transmitter

BOSCH

Installation Instructions for the RF3405E Wireless (RF) Inertia Transmitter

1.0 General Information

The RF3405E Inertia Transmitter is a magnetic and dry contact wireless transmitter with a built-in inertia sensor used for monitoring doors, windows, or other dry contact devices.

The inertia transmitter is equipped with internal reed contacts for use with an external magnet assembly and an inertia sensor for detecting shock. The transmitter can also accept a dual EOL resistor supervised dry contact input from an external device. A cover/wall tamper switch is provided.

Supervision is provided by periodically transmitting a supervisory signal to the receiver every 13 minutes if there is no other activity. All transmissions from the RF3405E send battery status information.

2.0 Mounting

2.1 Mounting Considerations

- The maximum range of the inertia transmitter, in open air, is approximately 300 m (98 ft.). Typically, keep this transmitter within 100 m (328 ft.) of the receiver to which it is assigned.
- Mounting the inertias transmitter on metal surfaces may reduce its RF range. Mounting it on ferrous metal (iron or steel) surfaces may affect the operation of the internal magnetic contact.
- Mount the inertia transmitter on the door or window frame and mount the magnet assembly on the moving portion.



The magnet assembly must be oriented as shown in *Figure 1*. The magnet must be no farther away than 10 mm (0.39 in.) from the body of the inertia sensor for normal operation.

2.2 Mounting the Transmitter

Refer to *Figure 2* when mounting the inertia transmitter.

1. Position the base plate over the desired location. If connecting to external contacts, position the mounting plate so the wiring passes through the wire entrance (callout #5).
2. If the transmitter is already installed, remove the inertia sensor bracket by pressing the inertia sensor tab (callout #1).
3. Remove the circuit board by pressing the circuit board tab (callout #2).
4. Mount the base plate using the 13 mm (0.51 in.) panhead screws (callout #3) through the base mounting holes (callout #4).
5. Refer to *Section 2.4 Mounting the Inertia Sensor* if the inertial sensor is used.

Figure 1: Magnet Location

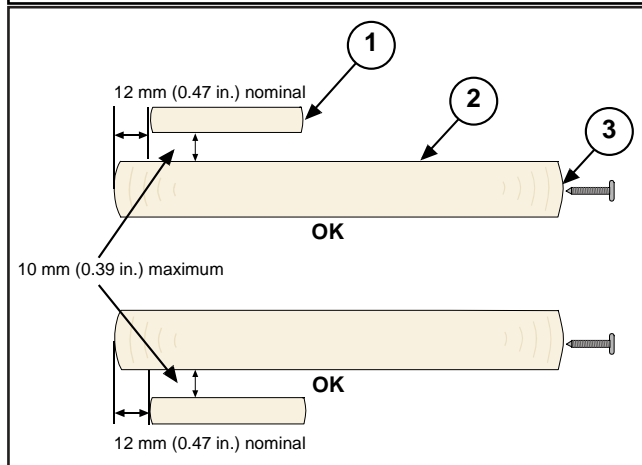

- 1 - Inertia transmitter
- 2 - Magnet
- 3 - Cover screw location

Figure 2: Base Plate

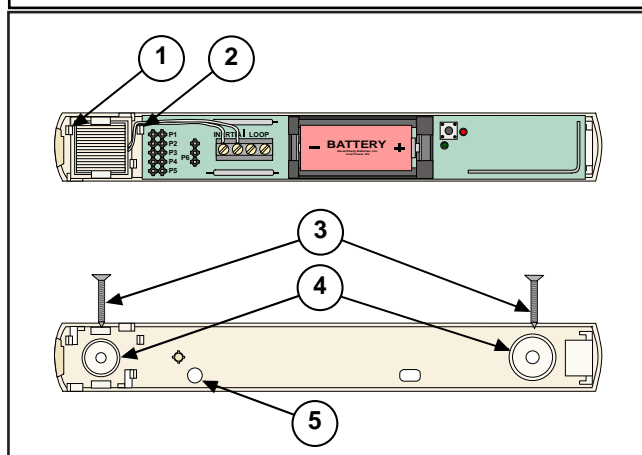

- 1 - Inertia sensor bracket
- 2 - Circuit board tab
- 3 - 13 mm (0.51 in.) panhead mounting screws
- 4 - Base mounting holes
- 5 - Wire entrance

2.3 Mounting the Magnet (if used)

Position the magnet base plate over the desired location, using the mounting configuration shown in *Figure 1*.

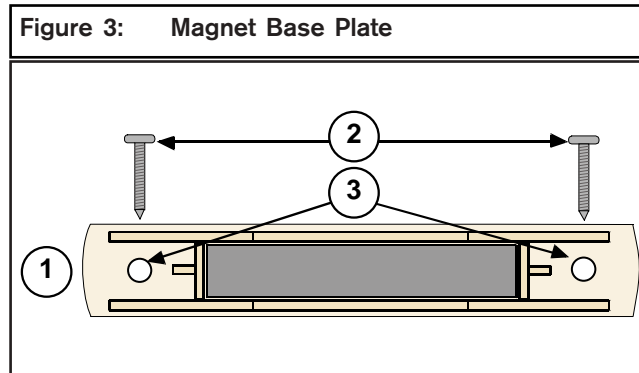

- 1 - Magnet assembly
- 2 - 16 mm (0.63 in.) flathead screws
- 3 - Magnet assembly mounting holes

2.4 Mounting the Inertia Sensor

1. Mount the inertia sensor so the wires are over the notched portion of the base plate (see *Figure 4*).

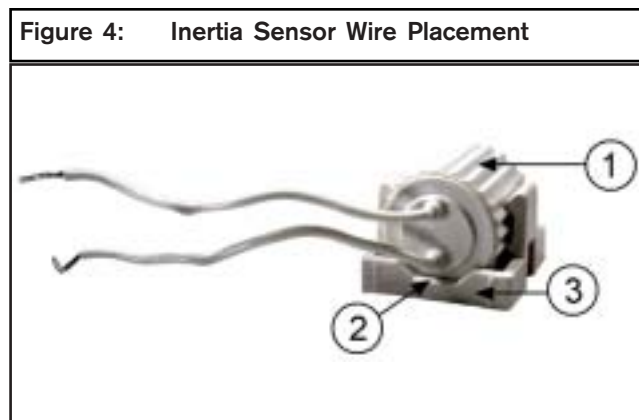

- 1 - Inertia sensor
- 2 - Notch in base bracket
- 3 - Inertia sensor base bracket

2. Press the inertia sensor all the way into the bracket.
3. You can mount the inertia sensor in four different positions on the base plate (see *Figure 5*). Route the wiring in a way that prevents crimping by the cover.

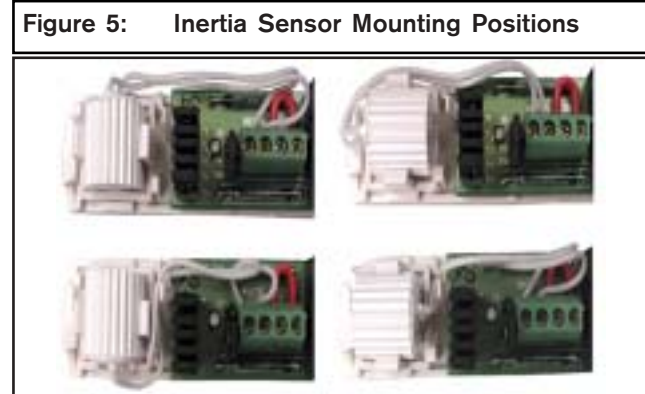

Orientation of the Inertia sensor is critical to the proper operation of the inertia detection function.

An UP arrow, imprinted on the body of this sensor, must always point upwards when mounted in the transmitter base.

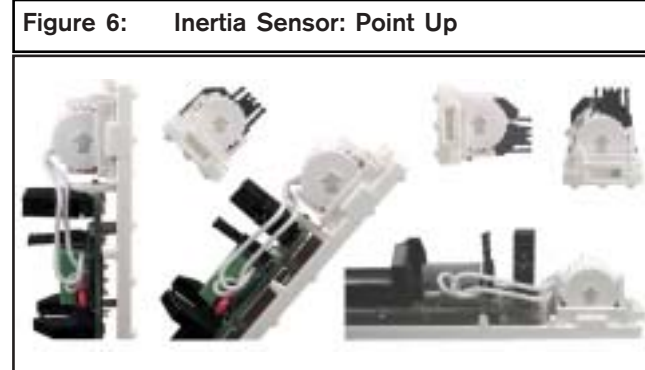

3.0 Wiring



The RF3405E can be wired for an inertia sensor or an external contact, but not both.

3.1 Wiring for the Inertia Sensor

Figure 7: Inertia Sensor Wiring

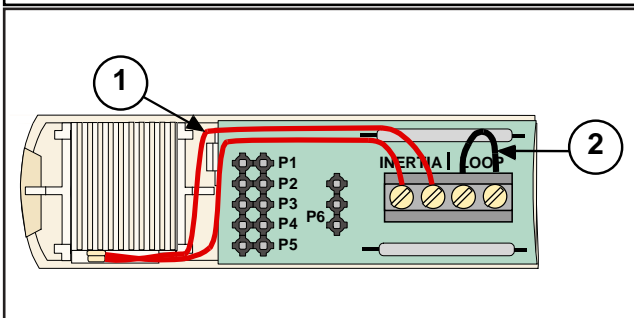

- 1 - Inertia sensor wires
- 2 - Wire jumper across loop terminals

3.2 Wiring for the External Contact

Figure 8: External Contact Wiring

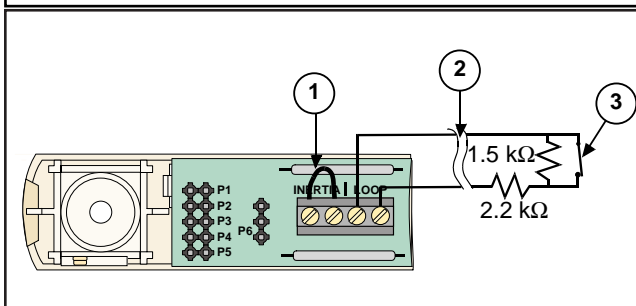

- 1 - Wire jumper across inertia terminals
- 2 - Length of contact loop can be up to 6 m (20 ft.)
- 3 - Normally closed (NC) contact



The wire jumper in the Loop terminals must be ON when using the Inertia function. The wire jumper in the Inertia terminals must be ON when using the External contact function.

4.0 Jumper Settings

4.1 Reed Switch Enable (Jumper P2)

If Jumper P2 is removed, the internal magnetic reed switches are enabled (see Figure 9).

Figure 9: P2 Reed Switch

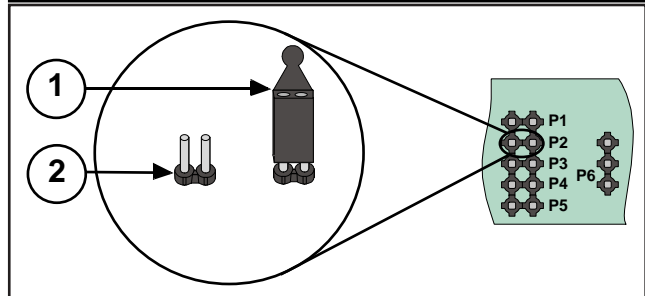

- 1 - Jumper on disables internal reed switches
- 2 - No jumper enables internal reed switches

4.2 Setting for Inertia or External Contact (Jumper P6)

The detector can be set to monitor the internal inertia sensor or a set of external contacts (see Figure 10).

Figure 10: Set Inertia or External Contact

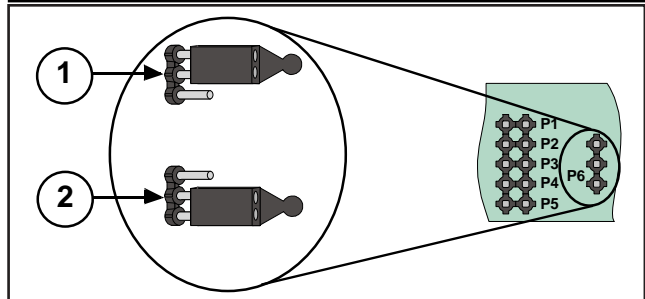

- 1 - External contact
- 2 - Inertia sensor

4.3 Minor and Gross Attack (Jumper P1)

If Jumper P1 is installed, the inertia detector reacts only to Gross Attacks (major movement). Minor movement or a series of taps does not activate the inertia detector. Jumper P4 and Jumper P5 settings determine the sensitivity of the inertia detector to Gross Attack (see Section 4.5).

Jumper P6 must be set for Inertia to enable these settings. See *Figure 11*.

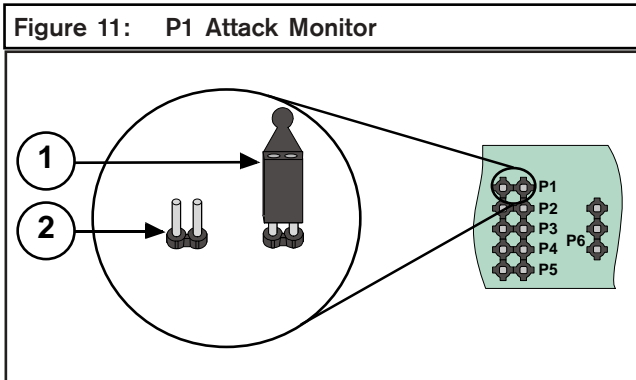

- 1 - No jumper for minor and gross attacks
- 2 - Jumper on for gross attack only

4.4 Pulses for Minor Attack (Jumper P3)

The setting of Jumper P3 determines the number of repetitive pulses needed to activate the inertia detector to a Minor Attack.

If Jumper P3 is removed, the inertia detector reacts to four repetitive pulses. This setting is only valid if Jumper P1 is set for Minor Attack and Jumper P6 is set for Inertia. See *Figure 12*.

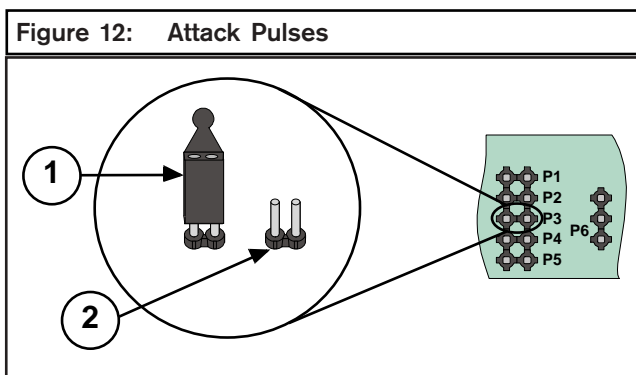

- 1 - Jumper on for eight repetitive pulses
- 2 - No jumper for four repetitive pulses

4.5 Sensitivity for Gross Attack (Jumpers P4 and P5)

These settings are valid only if Jumper P6 is set for Inertia.

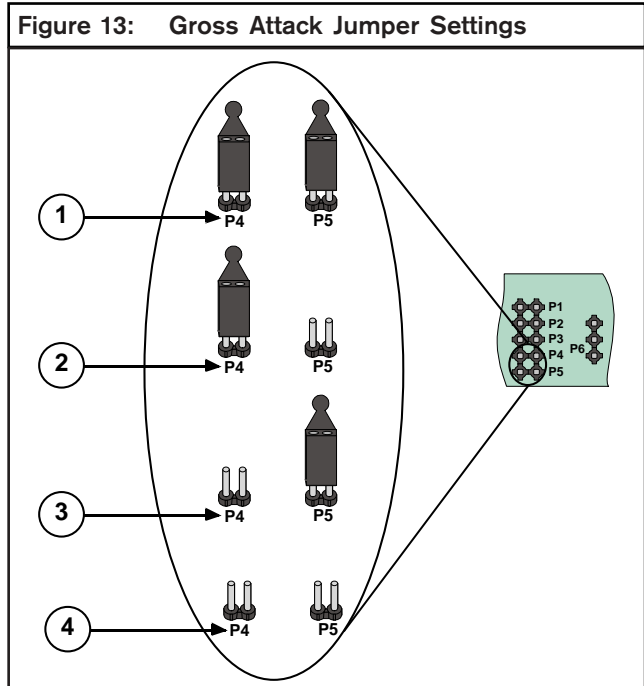

- 1 - Low sensitivity
- 2 - Low/Medium sensitivity
- 3 - Medium/High sensitivity
- 4 - High sensitivity

5.0 Installing the Battery

Be sure to observe the battery polarity (see *Figure 14*).

Figure 14: Battery Installation

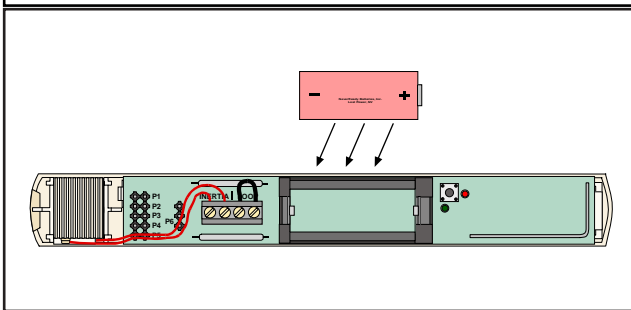

6.0 Programming the Panel

There is a two-part ID sticker located on the housing of the RF3405E (see *Figure 15*). You need the number on this sticker to program the inertia transmitter into the control panel.

Refer to the panel *Programming Guide* for programming information on wireless test devices.

Figure 15: ID Sticker

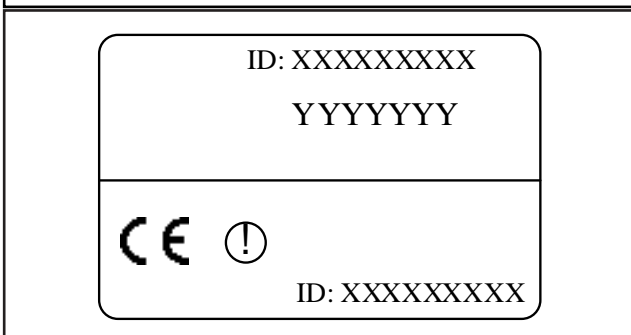

7.0 Testing the Detector

Once the detector is mounted, you can place it in Test Mode for 15 minutes by opening and then closing the detector cover, or by pushing both tamper springs then releasing one or both of them (if the cover is off). The LED flashes once (and then continues flashing dimly) to indicate it is in Test Mode. During the testing time, the LED flashes twice each time a Minor Inertia Attack occurs, a magnetic contact changes state (open or close), or any time the external contact (if used) changes state. The LED flashes three times for a Gross Inertia Attack.

If any jumpers are changed during Test Mode, the LED flashes once to indicate the change.

8.0 Specifications

Table 1: Specifications

Dimensions (H x W x D)	Transmitter: 2.7 cm x 2.4 cm x 16.9 cm (1.06 x 0.94 in. x 6.65 in.) Magnet: 1.9 cm x 1.3 cm x 16.9 cm (0.75 in. x 0.51 in. x 2.36 in.)
Operating Temperature	-20°C to +60°C (-4°F to +151°F); 0% to 95% relative humidity (non-condensing)
Frequency Band	433.42 MHz
Maximum RF Power	Less than 10 mW
Operating Voltage	Supplied by a 3 VDC lithium battery
Battery Life	A minimum of 3 years under normal operating conditions with recommended battery types (2 years if using the inertia sensor).
Recommended Battery Types	Duracell DL123A Energizer EL123AP Panasonic CR123A
Compatible Receiver	RF3227E
Supervisory Internal	13 minutes nominal

Notes:

Bosch Security Systems
130 Perinton Parkway
Fairport, NY 14450-9199 USA
www.boschsecurity.us
Customer Service: (800) 289-0096
Technical Support: (888) 886-6189

© 2003 Bosch Security Systems
Subject to change | Printed in the USA
47128C

BOSCH