

A x1 M4x18  
B x4 M6

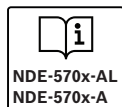

**Pendant interface plate with weather cap**  
NDA-5070-PIPW

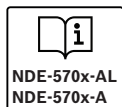
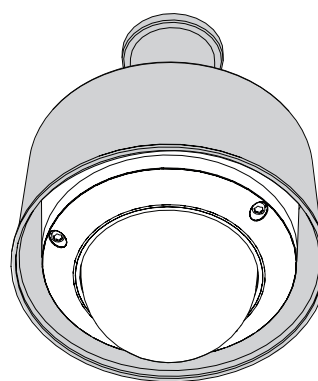
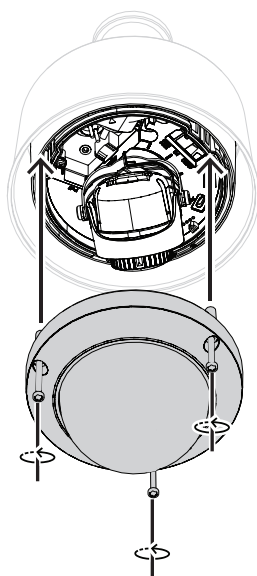
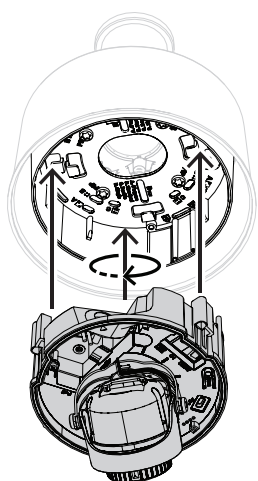
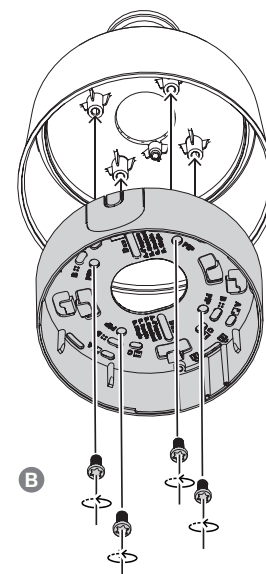
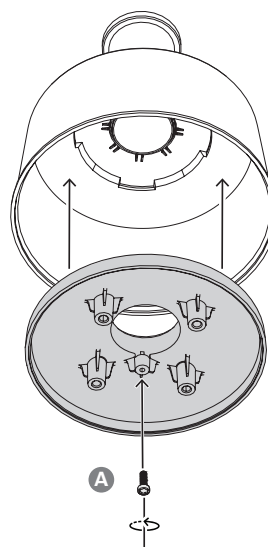
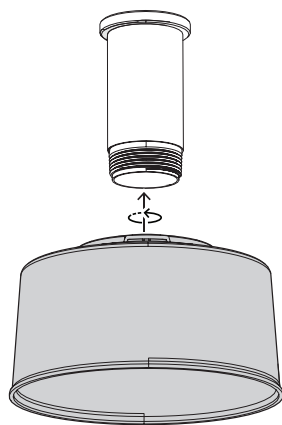
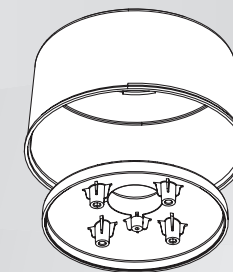

**en** Quick installation guide

**Bosch Security Systems B.V.**  
Torenallee 49  
5617 BA Eindhoven  
Netherlands  
**[www.boschsecurity.com](http://www.boschsecurity.com)**  
© Bosch Security Systems B.V., 2021