

# Installation Instructions for the DS7447E Keypad

## 1.0 General Information

The DS7447E (see *Figure 1*) is a 4-wire alphanumeric LCD keypad. Use it with the DS7060, DS7080i Series, DS7200 Series, and DS7400Xi Series control panels. The DS7447E supports all system functions and is required for local programming.

**Figure 1: Front View of DS7447E LCD Keypad**

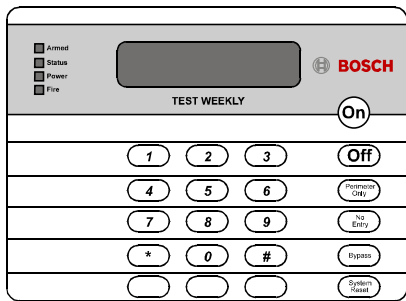

This keypad was not investigated by UL for use with DS7060, DS7080i Series and DS7400Xi Series of control panels.

The keypad can be surface mounted, mounted to a standard single or double gang box, or a 50.8 mm (4 in.) square box. See *Table 1* for general wiring guidelines.

**Table 1: Keypad Wire Guidelines**

Wire Gauge	#22 AWG (0.8 mm) minimum
Wire Type	No shield, 4-wire
Maximum distance allowed between control panel and each keypad	305 m (1000 ft.)

## 2.0 Keypad Addresses



Each keypad address must be set using address pins. The keypads must also be programmed at the control panel.

See *Figure 5* for the address and mode jumper locations.

1. Select a different address (0 to 32) for each keypad. See *Table 2* and *Table 3*.
2. Place the shorting jumpers over the address pins as described in *Table 2* and *Table 3*. In both tables, **ON** indicates a shorting jumper across both pins. *Figure 2* shows proper shorting jumper placements.

**Table 2: Keypad Address Selections for DS7060, DS7080i Series, and DS7400Xi Series Control Panels**

Module Address	Address Jumpers					Mode
	1	2	4	8	18	
0	OFF	OFF	OFF	OFF	OFF	OFF
1	<b>ON</b>	OFF	OFF	OFF	OFF	OFF
2	OFF	<b>ON</b>	OFF	OFF	OFF	OFF
3	<b>ON</b>	<b>ON</b>	OFF	OFF	OFF	OFF
4	OFF	OFF	<b>ON</b>	OFF	OFF	OFF
5	<b>ON</b>	OFF	<b>ON</b>	OFF	OFF	OFF
6	OFF	<b>ON</b>	<b>ON</b>	OFF	OFF	OFF
7	<b>ON</b>	<b>ON</b>	<b>ON</b>	OFF	OFF	OFF
8	OFF	OFF	OFF	<b>ON</b>	OFF	OFF
9	<b>ON</b>	OFF	OFF	<b>ON</b>	OFF	OFF
10	OFF	<b>ON</b>	OFF	<b>ON</b>	OFF	OFF
11	<b>ON</b>	<b>ON</b>	OFF	<b>ON</b>	OFF	OFF
12	OFF	OFF	<b>ON</b>	<b>ON</b>	OFF	OFF
13	<b>ON</b>	OFF	<b>ON</b>	<b>ON</b>	OFF	OFF
14	OFF	<b>ON</b>	<b>ON</b>	<b>ON</b>	OFF	OFF
15	<b>ON</b>	<b>ON</b>	<b>ON</b>	<b>ON</b>	OFF	OFF

**Figure 2: Shorting Jumper Placements**

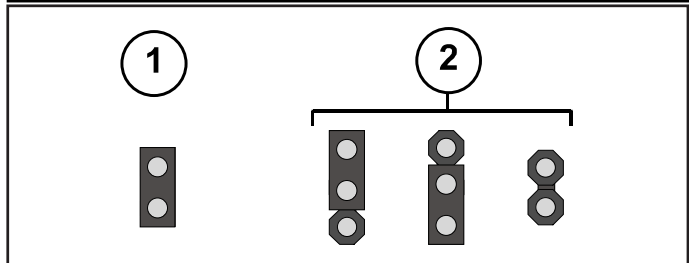

- 1 - Jumper plug ON (covers both pins)
- 2 - Jumper plug OFF (choice of three)

## 3.0 Location

Ideally, locate one keypad at the primary entry or exit door of the premises and within 305 m (1000 ft.) of the control panel. Do not mount the keypad outdoors. See *Section 8.0 Commercial Fire Applications (DS7400Xi)* for commercial fire restrictions.



**BOSCH**

**Table 3: Keypad Address Selections for Other Control Panels**

Module Address	Address Jumpers					Mode
	1	2	4	8	18	
0*	OFF	OFF	OFF	OFF	OFF	OFF
1	ON	OFF	OFF	OFF	OFF	ON
2	OFF	ON	OFF	OFF	OFF	ON
3	ON	ON	OFF	OFF	OFF	ON
4	OFF	OFF	ON	OFF	OFF	ON
5	ON	OFF	ON	OFF	OFF	ON
6	OFF	ON	ON	OFF	OFF	ON
7	ON	ON	ON	OFF	OFF	ON
8	OFF	OFF	OFF	ON	OFF	ON
9	ON	OFF	OFF	ON	OFF	ON
10	OFF	ON	OFF	ON	OFF	ON
11	ON	ON	OFF	ON	OFF	ON
12	OFF	OFF	ON	ON	OFF	ON
13	ON	OFF	ON	ON	OFF	ON
14	OFF	ON	ON	ON	OFF	ON
15	ON	ON	ON	ON	OFF	ON
17	ON	OFF	OFF	OFF	ON	ON
18	OFF	ON	OFF	OFF	ON	ON
19	ON	ON	OFF	OFF	ON	ON
20	OFF	OFF	ON	OFF	ON	ON
21	ON	OFF	ON	OFF	ON	ON
22	OFF	ON	ON	OFF	ON	ON
23	ON	ON	ON	OFF	ON	ON
24	OFF	OFF	OFF	ON	ON	ON
25	ON	OFF	OFF	ON	ON	ON
26	OFF	ON	OFF	ON	ON	ON
27	ON	ON	OFF	ON	ON	ON
28	OFF	OFF	ON	ON	ON	ON
29	ON	OFF	ON	ON	ON	ON
30	OFF	ON	ON	ON	ON	ON
31	ON	ON	ON	ON	ON	ON
32	OFF	OFF	OFF	OFF	OFF	ON

\* Installer's Mode Address Setting: Use for direct connection of installer's keypad.

### 4.0 Mounting

Mount the keypad no higher than shoulder height of the shortest person using the system.

1. Insert a small flat-head screwdriver in each slot at the bottom of the base.
2. Press up and pull the cover off.
3. Using the base as a template, mark the location of the selected mounting holes (see *Figure 3*).
4. Provide an opening on the mounting surface for the wiring.
5. Pre-start the mounting screws. **Do not secure the base at this time.**

**Figure 3: Back View of Keypad**

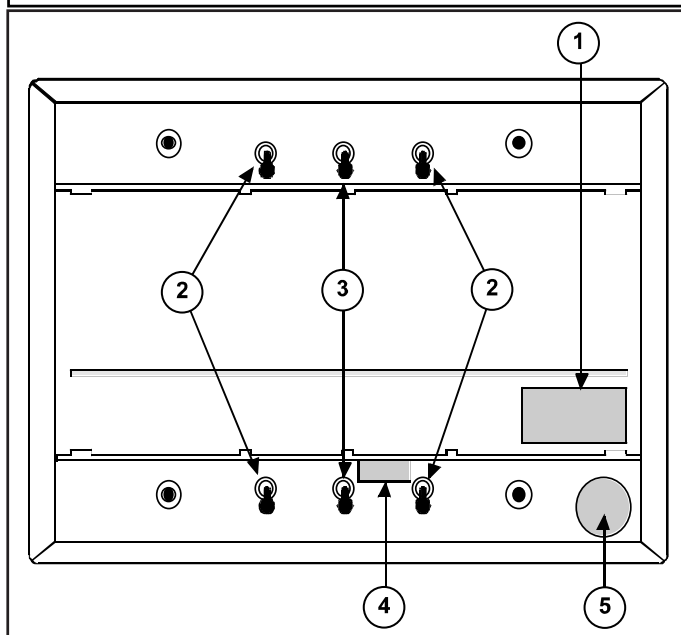

- 1 - Terminal strip opening (Do not use as wire entrance.)
- 2 - Double gang mounting slots (4)
- 3 - Single gang mounting slots (2)
- 4 - Wire entrance
- 5 - Sounder opening

### 5.0 Wiring



Be sure all wiring is unpowered before routing.

#### 5.1 Control Panel to Keypad Wiring

1. Route wiring from the control panel to the keypads.  
Place no more than two keypads along any single 305 m (1000 ft.) run of #22 AWG (0.8 mm) wire. Three keypads can be used on any single 1305 m (1000 ft.) run of #18 AWG (1.2 mm) wire.
2. Insert wiring through the wire entrance in the keypad base and secure the base (see *Figure 3*).
3. Connect the wiring to the keypad terminal strip (see *Figure 4*).
4. Place the keypad cover on the base. While feeding the excess wiring from the back of the base, press the cover straight in until it latches.

**Figure 4: Keypad Terminal Connections**

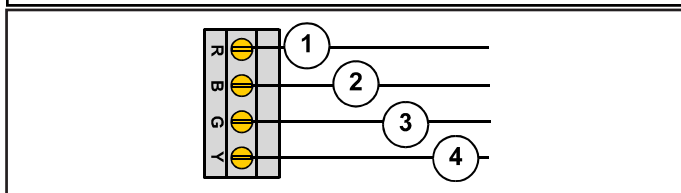

- 1 - Power + (red)
- 2 - Power - (black)
- 3 - Data in (green)
- 4 - Data out (yellow)

## 6.0 DS7447i Contrast Control

Increase the DS7447E keypad contrast by turning the contrast control clockwise. Decrease the contrast by turning the control counterclockwise.

See *Figure 5* for the location of the contrast control.

**Figure 5: Internal View of DS7447E LCD Keypad**

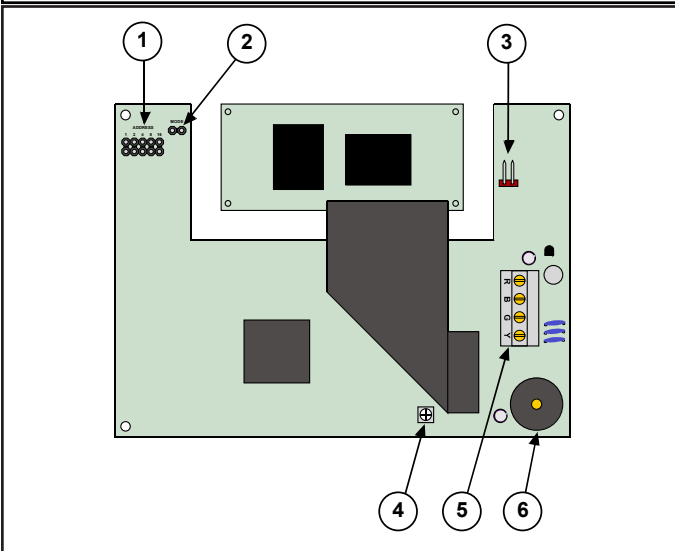

- 1 - Address jumper pins
- 2 - Mode pins
- 3 - Access relay option pins
- 4 - Contrast control
- 5 - Option bus terminals
- 6 - Sounder

## 7.0 Special Key Labeling



Do not label unprogrammed keys.

Consult your control panel programming instructions for specific function key assignments.

*Figure 6* shows typical function key assignments.

**Figure 6: Special Key Labeling**

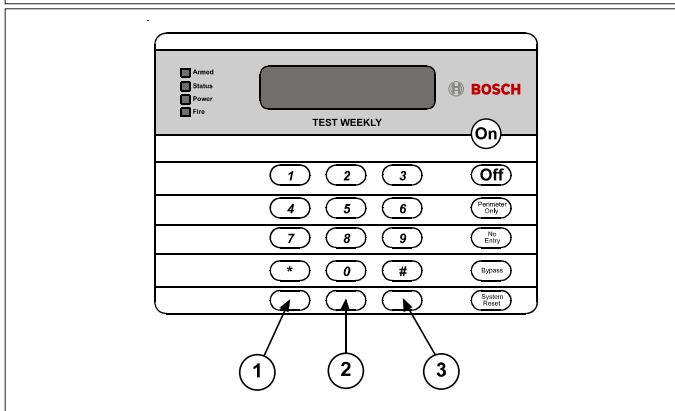

- 1 - Fire
- 2 - Special emergency
- 3 - Panic

## 8.0 Commercial Fire Applications (DS7400Xi Series)

### 8.1 Single Keypad Use

The keypad must be used on the keypad bus and mounted to the front of the control enclosure. If the keypad is within the same room as the control equipment and the wire is run in conduit (or equally protected against mechanical damage), the keypad must be within 6 m (20 ft.) of the control equipment. The keypad must be assigned as keypad Address 1.

### 8.2 Multiple Keypad Use

Use only one keypad on the panel option bus and assign it as keypad Addresses 11 to 14.

Mount the keypad to the front of the control enclosure. If the keypad is within the same room as the control equipment and the wire is run in conduit (or equally protected against mechanical damage), the keypad must be within 6 m (20 ft.) of the control equipment.

## 9.0 Instruction Label and Slide

Two instruction labels are provided. Place one of the labels on the pull-out slide. Install the slide so it pulls from the left or right (slide it into rear of base). See *Figure 7*.

**Figure 7: Instruction Label and Slide Installation**

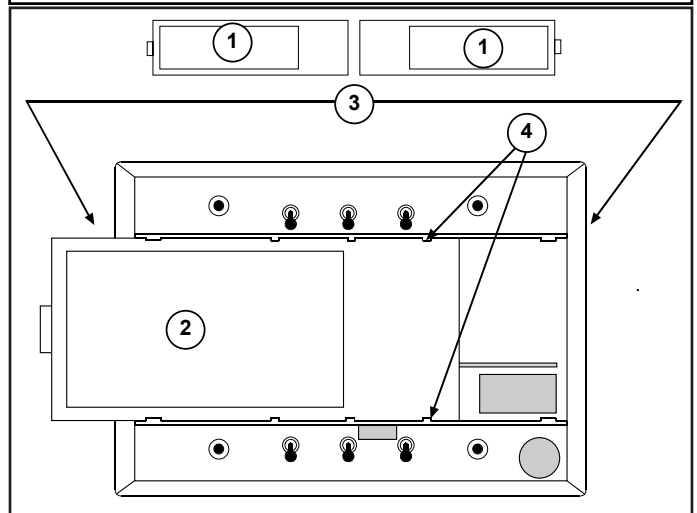

- 1 - Label
- 2 - Label (writing on reverse side)
- 3 - Slide label in either side.
- 4 - Align label behind both sets of teeth.

Use *Instruction Label* (P/N: 28815) if the keypad you are installing is for the DS7060, DS7080i Series, and DS7400Xi Series Control Panels.

Use *Instruction Label* (P/N: 49646) if the keypad you are installing is for the DS7200 Series Control Panels.



Be careful when installing the label. Place it as close to the pull-tab as possible.

## 10.0 Troubleshooting

**Table 4: Troubleshooting**

Keypad Notification	Possible Causes
DS7447E continuous sounder and System Fault display.	<ul style="list-style-type: none"><li>• The yellow and green wires are disconnected.</li><li>• The control panel malfunctioned. Replace the control panel.</li></ul>
DS7447E continuous sounder and Not Programmed display.	<ul style="list-style-type: none"><li>• The keypad was not programmed properly at the control panel.</li></ul>
DS7447E Three-beep error tone on all keypads.	<ul style="list-style-type: none"><li>• Two or more keypads have same address.</li><li>• DS7400 Series Only: DS7430 MUX Module not installed on main board correctly. Check pin alignment.</li><li>• DS7400 Series only: The keypad and another device on the option bus have the same address.</li></ul>