

1 |

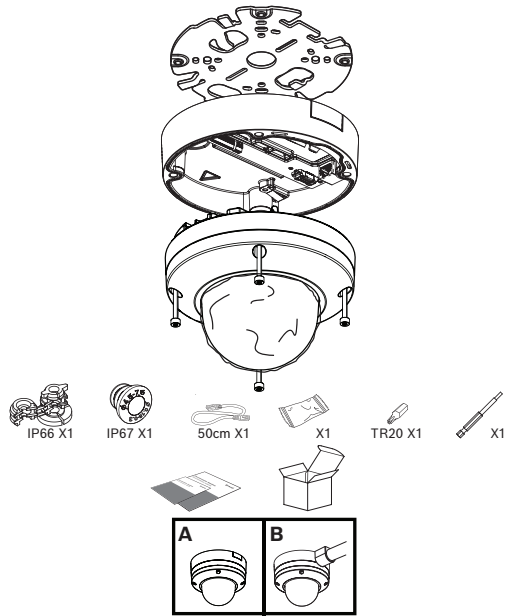

2 |

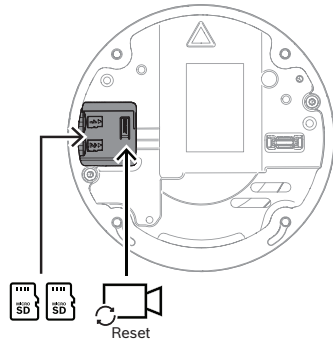

3 |

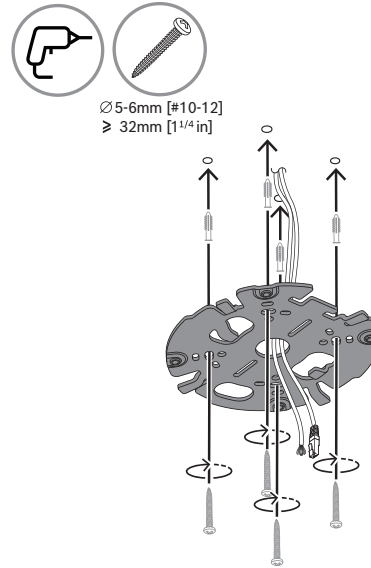

4 |

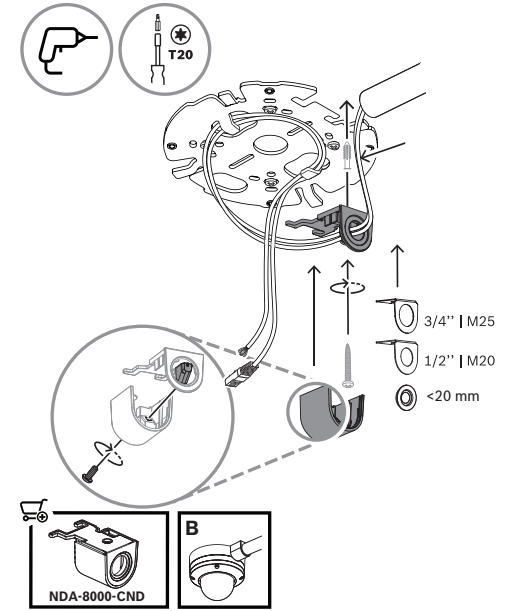

5 |

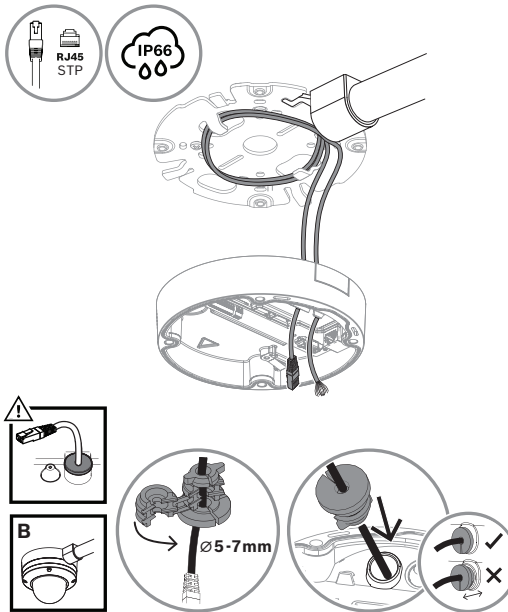

6 |

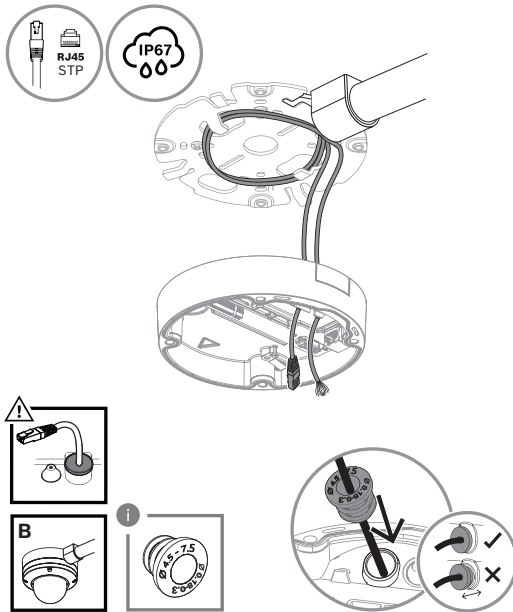

7 |

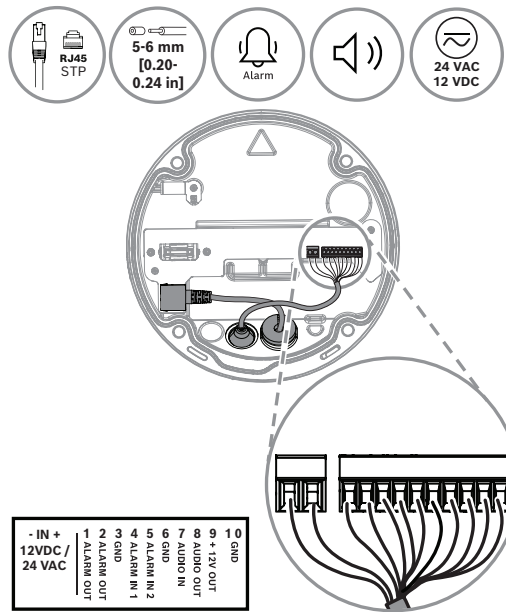

8 |

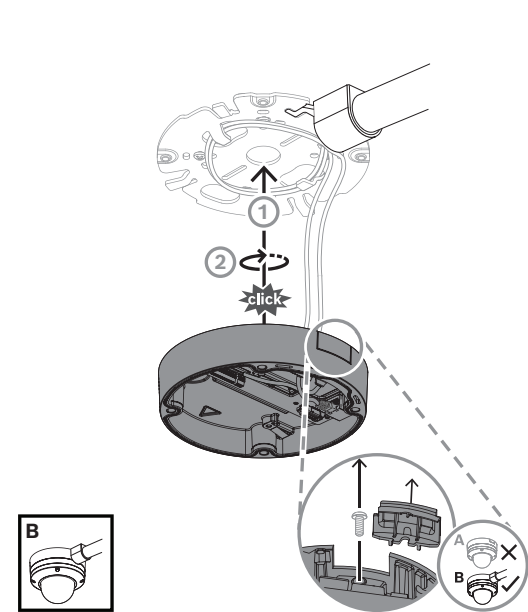

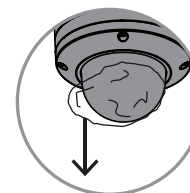
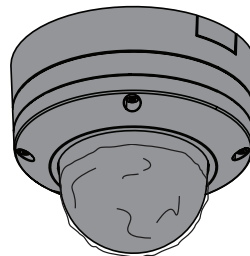
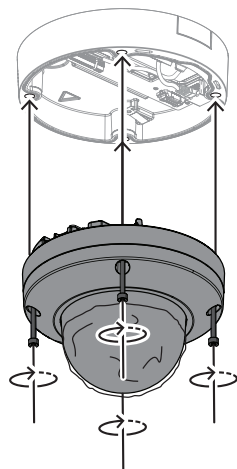
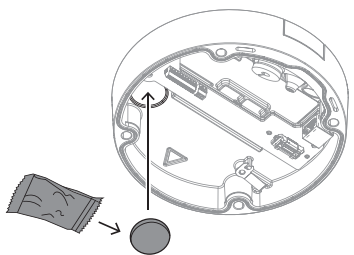

**FLEXIDOME 8100i**

NDE-8702-RX | NDE-8702-RXT |  
NDE-8703-RX | NDE-8703-RXT |  
NDE-8703-R | NDE-8703-RT | NDE-8704-R |  
NDE-8704-RT | NDE-8704-RX

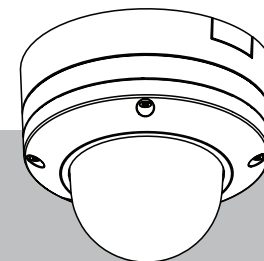

en Quick installation guide

**Project Assistant app**

Windows | iOS | Android

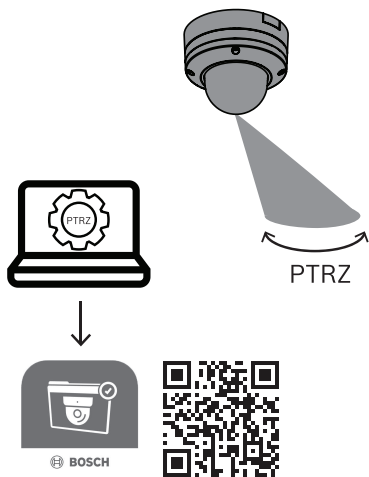

<https://downloadstore.boschsecurity.com/>

**Bosch Security Systems B.V.**

Torenallee 49

5617 BA Eindhoven

Netherlands

[www.boschsecurity.com](http://www.boschsecurity.com)

© Bosch Security Systems B.V., 2024

**Building solutions for a better life**