

Installation Instructions for the MX934i Multiplex PIR Intrusion Detector

1.0 Specifications

- **Input Power:** Connects directly to the Multiplex Bus of the Control Panel and optionally to an auxiliary 12 VDC source.
- **Current Draw:**
 - 2-Wire:**
 - LED Off:** <350 μ A draw on Mux Bus.
 - In Alarm; LED On:** 2 mA draw on Mux Bus.
 - 4-Wire:**
 - LED Off:** <350 μ A draw on Mux Bus. 0 mA draw on Aux. power.
 - In Alarm; LED On:** <350 μ A draw on Mux Bus. 3 mA draw on Aux. power.
- **Standby Power:** There is no internal standby battery. Connect to DC power sources capable of supplying standby power if primary power fails. For each hour of standby time needed, 350 μ Ah are required. *For UL Listed Requirements, four hours (1400 μ Ah) minimum are required.*
- **Coverage:**
 - Broad (standard):** 35 ft. by 35 ft. (10.7 m by 10.7 m)
 - Barrier (optional):** 35 ft. by 10 ft. (10.7 m by 3.1 m)
 - Long Range (optional):** 70 ft. by 10 ft. (21.4 m by 3.1 m)
- **Sensitivity:** Selectable for Standard, Intermediate, or High.
- **Tamper:** A tamper condition is signaled through the Multiplex Bus and displays at the keypads.
- **Temperature:** The storage and operating temperature range is -20°F to +120°F (-29°C to +49°C). *For UL Listed Requirements, the temperature range is +32°F to +120°F (0°C to +49°C).*
- **Control Panel Requirements:** DS7400, DS7400X, or DS7400Xi control panel with a DS7430 or DS7436 multiplex expansion module. The DS7400 and DS7400X require ROM version 1.07 or greater. 9000 Series Control/Communicators with D8125MUX Module installed.
- **Options:** B335 Low Profile Swivel Mount Bracket, B338 Ceiling Mount Bracket, OMB93-3* Barrier Mirror, OMLR93-3* Long Range Mirror.
**Shipped in packages of three.*

NOTE: Misalignment of the detector when using an optional mounting bracket may reduce range and increase dead zones.

• **Reading Bosch Security Systems, Inc. Product Date Codes**
For Product Date Code information, refer to the Bosch Security Systems, Inc. Web site at: <http://www.boschsecurity.com/datecodes/>

2.0 Control Panel Programming

Refer to the multiplex programming section of your Control Panel Reference Guide for information on programming multiplex zones for this device.

3.0 Mounting

Avoid

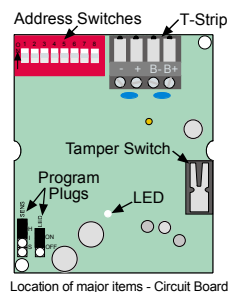
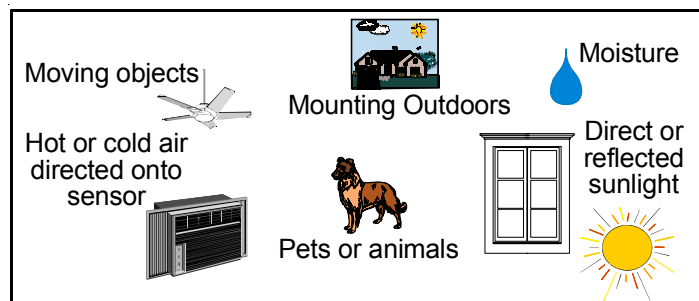

Location of major items - Circuit Board

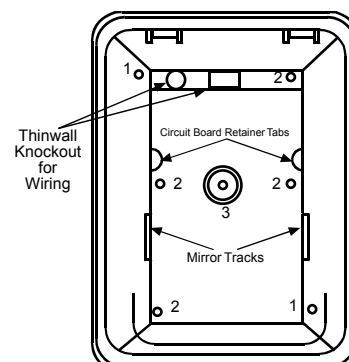

1 = Corner 2 = Surface 3 = Bracket
Rear enclosure and mounting holes



The mounting surface should be solid and vibration free.

- Select a location that is most likely to intercept an intruder moving across the coverage pattern. The recommended mounting height range is 6.5 ft. to 8.5 ft. (2 m to 2.6 m).
- Remove the cover. Insert a thin flathead screwdriver into the notch at the bottom of the cover and pry up.
- Remove the circuit board/mirror unit from the enclosure. Push the board/mirror unit toward the top of the enclosure until it clears its four retainer tabs, then lift it out.
- Open the knock-out wire entrance and route the wiring through.

3.1 Surface or Corner Mounting

- Open two holes for surface or corner mounting.
- Mark the location for the mounting screws. Use the enclosure as a template. Pre-start the mounting screws.
- Securely attach the detector.
- Replace the circuit board/mirror unit.
- Select the Vertical Angle.

Mirror Information: The mirror is adjustable from +1° to -18° vertically by sliding the mirror forward or back and $\pm 10^\circ$ horizontally by rocking the mirror side to side. To change the mirror, just pull it out from its resting grooves.

NOTE: Excessive handling of the mirror surfaces may lead to performance degradation.

- The following chart will help you set the correct Vertical Angle based on the mounting height, mirror type, and desired range.

Mounting Height	Broad		Barrier		Long Range	
	20 (6)	35 (10)	20 (6)	35 (10)	40 (12)	70 (20)
6.5 (2.0)	-10°	-6°	-6°	-4°	-5°	-3°
7.5 (2.3)	-12°	-8°	-8°	-6°	-7°	-5°
8.5 (2.6)	-14°	-10°	-12°	-8°	-9°	-5°

Height and desired Range listed in feet (meters)

- The angle adjust markings are on the mirror. Slide the mirror forward or back until the angle hash marks are in-line with the markers on each side of the frame.

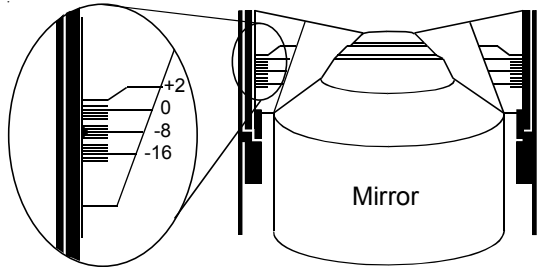

4.0 Wiring



Only apply power after all connections have been made and inspected.

- Connect wiring as shown.

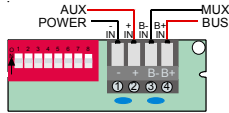

NOTE: Do not coil excess wiring inside unit.

- Seal the Wire Entrance using the foam plug provided.

Terminal Descriptions

- **1 (-) and 2 (+):** Connect to the AUX Power of the control panel. This connection is only required if LED operation (other than during the walk test) is required. Use no smaller than #22 AWG (0.8 mm) wire between the detector and the control panel.
- **3 (B-) and 4 (B+):** Connect to the Multiplex Bus of the control panel. Use no smaller than #22 AWG (0.8 mm) wire between the detector and the control panel.

5.0 Configuring Detector

5.1 LED Operation Jumper

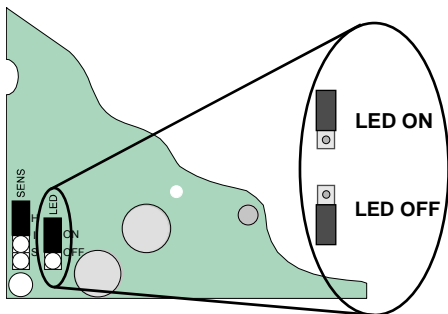

- **ON:** Allows the LED to operate when activated by alarm.
- **OFF:** The LED will not operate on alarm.



If the detector is powered by the MUX Bus only, the LED is for Walk Test purposes only. Disable the LED when Walk Testing is complete. To disable the LED, place the jumper in the OFF position. **If the detector has AUX Power supplied,** the LED operation may be left ON during normal use.

5.2 Sensitivity Mode

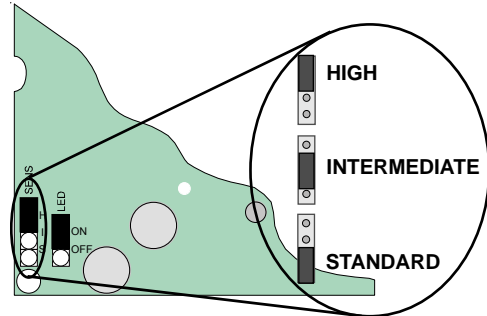

- **Standard Sensitivity:** Recommended setting for maximum false alarm immunity. Tolerates environment extremes on this setting. Not recommended for Long Range or Barrier type patterns. The detector is shipped in Standard Sensitivity mode.
- **Intermediate Sensitivity:** Recommended setting for any location where an intruder is expected to cover only a small portion of the protected area. Tolerates normal environments on this setting. This setting will improve your intruder catch performance.
- **High Sensitivity:** Fast response to intruder signals. For use in quiet environments where thermal and illumination transients are not anticipated.

6.0 Address Switch Settings

- Set the address switch settings (see page 3) before connecting the MX934i to the multiplex bus.



No two devices may be set to the same address. Having two or more units set to the same address may prevent fault detection or cause multiplex bus failure.

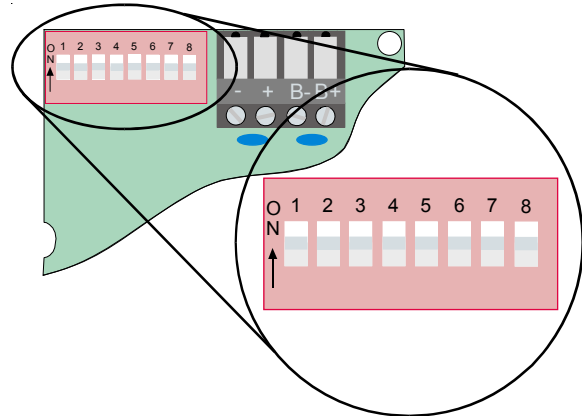

- You can find the Address Switch Settings using the chart on page 3, or by calculating the decimal number of the address.

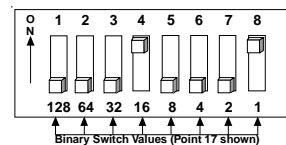

Zone (Point) Addresses 001 through 008 are reserved for "on board" points on the DS7400(Xi) Series control panels.

Do not set any multiplex devices for Addresses 001-008 when using a DS7400(Xi) Series control panel.

● = SWITCH ON (CLOSED)

ZONE (POINT) ADDRESS	SWITCH NUMBER							
	1	2	3	4	5	6	7	8
001								●
002							●	
003							●	●
004							●	●
005							●	●
006							●	●
007							●	●
008							●	●
009							●	●
010							●	●
011							●	●
012							●	●
013							●	●
014							●	●
015							●	●
016							●	●
017							●	●
018							●	●
019							●	●
020							●	●
021							●	●
022							●	●
023							●	●
024							●	●
025							●	●
026							●	●
027							●	●
028							●	●
029							●	●
030							●	●
031							●	●
032							●	●
033							●	●
034							●	●
035							●	●
036							●	●
037							●	●
038							●	●
039							●	●
040							●	●
041							●	●
042							●	●
043							●	●
044							●	●
045							●	●
046							●	●
047							●	●
048							●	●
049							●	●
050							●	●
051							●	●
052							●	●
053							●	●
054							●	●
055							●	●
056							●	●
057							●	●
058							●	●
059							●	●
060							●	●
061							●	●
062							●	●
063							●	●
064							●	●

● = SWITCH ON (CLOSED)

ZONE (POINT) ADDRESS	SWITCH NUMBER							
	1	2	3	4	5	6	7	8
065		●						●
066		●						●
067		●						●
068		●						●
069		●						●
070		●						●
071		●						●
072		●						●
073		●						●
074		●						●
075		●						●
076		●						●
077		●						●
078		●						●
079		●						●
080		●						●
081		●						●
082		●						●
083		●						●
084		●						●
085		●						●
086		●						●
087		●						●
088		●						●
089		●						●
090		●						●
091		●						●
092		●						●
093		●						●
094		●						●
095		●						●
096		●						●
097		●						●
098		●						●
099		●						●
100		●						●
101		●						●
102		●						●
103		●						●
104		●						●
105		●						●
106		●						●
107		●						●
108		●						●
109		●						●
110		●						●
111		●						●
112		●						●
113		●						●
114		●						●
115		●						●
116		●						●
117		●						●
118		●						●
119		●						●
120		●						●
121		●						●
122		●						●
123		●						●
124		●						●
125		●						●
126		●						●
127		●						●
128		●						●

● = SWITCH ON (CLOSED)

ZONE (POINT) ADDRESS	SWITCH NUMBER							
	1	2	3	4	5	6	7	8
129	●							●
130	●							●
131	●							●
132	●							●
133	●							●
134	●							●
135	●							●
136	●							●
137	●							●
138	●							●
139	●							●
140	●							●
141	●							●
142	●							●
143	●							●
144	●							●
145	●							●
146	●							●
147	●							●
148	●							●
149	●							●
150	●							●
151	●							●
152	●							●
153	●							●
154	●							●
155	●							●
156	●							●
157	●							●
158	●							●
159	●							●
160	●							●
161	●							●
162	●							●
163	●							●
164	●							●
165	●							●
166	●							●
167	●							●
168	●							●
169	●							●
170	●							●
171	●							●
172	●							●
173	●							●
174	●							●
175	●							●
176	●							●
177	●							●
178	●							●
179	●							●
180	●							●
181	●							●
182	●							●
183	●							●
184	●							●
185	●							●
186	●							●
187	●							●
188	●							●
189	●							●
190	●							●
191	●							●
192	●							●

● = SWITCH ON (CLOSED)

ZONE (POINT) ADDRESS	SWITCH NUMBER							
	1	2	3	4	5	6	7	8
193	●	●						●
194	●	●						●
195	●	●						●
196	●	●						●
197	●	●						●
198	●	●						●
199	●	●						●
200	●	●						●
201	●	●						●
202	●	●						●
203	●	●						●
204	●	●						●
205	●	●						●
206	●	●						●
207	●	●						●
208	●	●						●
209	●	●						●
210	●	●						●
211	●	●						●
212	●	●						●
213	●	●						●
214	●	●						●
215	●	●						●
216	●	●						●
217	●	●						●
218	●	●						●
219	●	●						●
220	●	●						●
221	●	●						●
222	●	●						●
223	●	●						●
224	●	●						●
225	●	●						●
226	●	●						●
227	●	●						●
228	●	●						●
229	●	●						●
230	●	●						●
231	●	●						●
232	●	●						●
233	●	●						●
234	●	●						●
235	●	●						●
236	●	●						●
237	●	●						●
238	●	●						●
239	●	●						

7.0 Setup and Walk Testing



Before walk testing, the system should be fully wired, powered, and programmed.

- Configure LED Operation Jumper to LED ON.
- Replace the front cover.

NOTE: All testing must be performed with the front cover in place.

- Wait at least two minutes (with no motion in the coverage area) for the detector to setup.
- Walk test **across** the coverage pattern.
- The edge of the coverage is determined by activation of the LED.
- Walk test the unit from both directions to determine the boundaries.

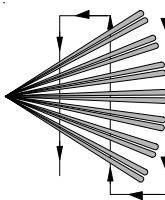

On 2-wire systems, configure the LED to OFF when finished with walk tests.

**Broad Coverage
Top View**

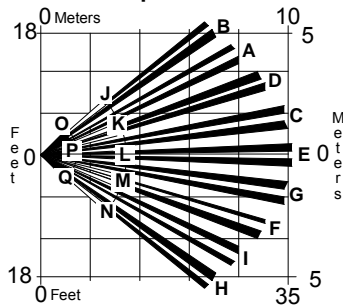

Side View

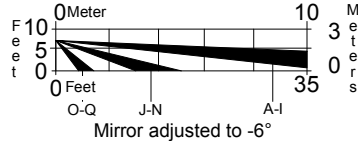

**Barrier Coverage
Top View**

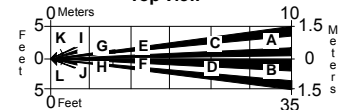

Side View

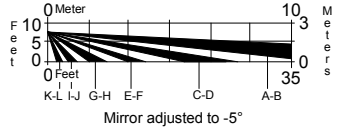

**Long Range Coverage
Top View**

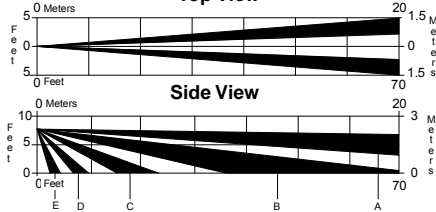

Side View



8.0 Maintenance

Consult your Control Panel's User's Guide for the procedure on performing a zone test. Performing a zone test on a regular basis assures an alarm output prior to arming the system.

9.0 Coverage Patterns

- Refer to the mirror module and pattern drawings for masking information.
- Before masking, be sure the chosen mirror surface is the correct one. When removing masking, remember, many adhesives will either destroy the mirror's surface or leave residue behind to reduce coverage performance.
- This product is factory assembled with the look down zones (O, P, and Q) masked out. If you wish to use these zones, simply remove the masking tape from the lens.

To Remove Mask, peel back tab

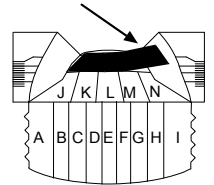

**Mirror Segment
to Pattern Reference**

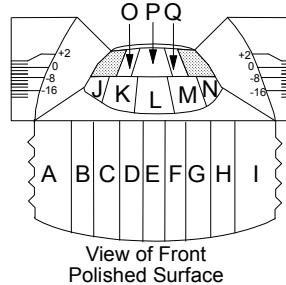

**View of Front
Polished Surface**

**Mirror Segment
to Pattern Reference**

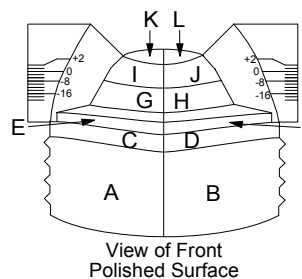

**View of Front
Polished Surface**

**Mirror Segment
to Pattern Reference**

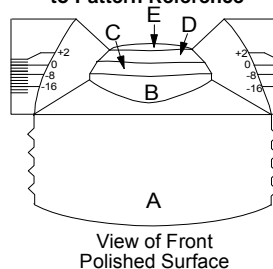

**View of Front
Polished Surface**

