

AUTODOME IP starlight 5100i



- ▶ 20X, 4MP high detail at fast speeds (60 fps)
- ▶ Starlight technology with 1/1.8 inch ultra HD sensor for excellent low-light performance
- ▶ HDR X -- High Dynamic Range to see every detail in both bright and dark areas of the scene without motion-related artifacts
- ▶ Intelligent streaming, IDNR and H.265 for a decreased bit rate of up to 80%
- ▶ Built-in Essential Video Analytics to trigger relevant alerts and quickly retrieve data

The AUTODOME IP starlight 5100i camera extends the camera range of the series to the next level. The camera has a 1/2-inch, 4MP sensor, which is specially tuned for applications that need surveillance in scenes with varying light levels.

The camera has an integrated 20X optical zoom to identify people at a maximum distance of 168 meters (551 feet).

The smart camera features Essential Video Analytics, which detects objects within, entering, or leaving an area or crossing a line and provides instant alerts. This feature lets operators react early and quickly to possible intrusions, and prevent damage of property or assets.

Functions

Outstanding image quality

The 1/1.8-inch CMOS HD sensor combines outstanding sensitivity and sophisticated noise suppression with High dynamic range of 133dB. The camera provides superior low-light performance as well as outstanding image quality, with sharp focus details and excellent color reproduction even under challenging lighting conditions.

Pre-programmed user modes

The camera has several pre-configured scene modes with the best settings for various applications. With one click, users can optimize image settings to match the camera's lighting conditions. Users can also configure individual image settings.

- Standard: For indoor fluorescent lighting.
- Sodium-lighting: For scenarios where the video is captured under sunlight in the day or under sodium vapor lamp at night.
- Vibrant: For enhanced contrast, sharpness, and saturation

H.265 high-efficiency video encoding

The camera is designed on the most efficient and powerful H.264 and H.265/HEVC encoding platform. The camera is capable of delivering high-quality and high-resolution video with very low network load. With a doubling of encoding efficiency, H.265 is the compression standard of choice for IP video surveillance systems.

Intelligent streaming

Smart encoding capabilities, together with Intelligent Dynamic Noise Reduction technology and analytics, make the bandwidth consumption drop to extremely low levels. Only relevant information in the scene, such as motion or objects found with the analytics, are encoded.

Support for H.264 and H.265 with Encoder Regions

Set a region in the field of view and define a specific encoder profile to it. This setting reduces the bitrate of the stream further than intelligent streaming alone.

Recording and storage management

Recording management can be controlled by the Bosch Video Recording Manager application, or the camera can use local storage and iSCSI targets directly without any recording software.

A memory card with a maximum of 32 GB (microSDHC) / 2 TB (microSDXC) can be used for recording *at the edge* or for Automatic Network Replenishment (ANR) technology to improve the overall recording reliability.

Pre-alarm recording in RAM reduces bandwidth consumption on the network and extends the effective life of the memory card.

Essential Video Analytics on the edge

The camera includes the latest release of Essential Video Analytics application from Bosch for use on Pre-positions.

The Essential Video Analytics application provides reliable video analytics for small and medium business, large retail stores, commercial buildings, and warehouses.

Advanced tasks like multiple line crossing, loitering, idle / removed object detection, crowd density estimation, occupancy and people counting are available for live alarming and forensic search. Object filters based on size, speed, direction, aspect ratio, and color can be defined.

A simplified calibration mode reduces installation time significantly, because you only need to enter the installation height once for each camera, independent of pre-positions.

After the camera is calibrated, the analytics engine can automatically classify objects as upright person, car, bike, or truck.

Sophisticated alarm responses

The camera supports advanced alarm control that uses sophisticated rules-based logic to determine how to manage alarms. In its most basic form, a rule could define which input(s) should activate which output(s). In a more complex form, inputs and outputs can be combined with pre-defined or user-specified commands to perform advanced camera functions.

Superior privacy masking

The camera allows for a total of 32 individual privacy masks, with up to eight masks displayed in the same scene. Each mask can be programmed with eight corners. Each mask changes size and shape smoothly and quickly, ensuring that the covered object cannot be seen.

With the AUTO Privacy Mask, the color of the Privacy Mask will adapt to the color of the surroundings.

DORI coverage

DORI (Detect, Observe, Recognize, Identify) is a standard system (EN-62676-4) for defining the ability of a person viewing the video to distinguish persons or objects within a covered area. The maximum distance at which a camera/lens combination can meet these criteria is shown below:

DORI	Distance to object		
	WIDE 1X	TELE 20X	Scene width
Detection 25 px/m (8 px/ft)	87m (285 ft)	1676 m (5498 ft)	102 m (336 ft)
Observation 63 px/m (19 px/ft)	34 m (113 ft)	665 m (2182 ft)	41 m (133 ft)
Recognition 125 px/m (38 px/ft)	17 m (57 ft)	335 m (1100 ft)	20 m (67.2 ft)
Identification 250 px/m (76 px/ft)	9 m (28 ft)	168 m (550 ft)	10 m (33.6 ft)

Data security

Special measures are necessary to ensure the highest level of security for device access and data transport. On initial setup, the camera is only accessible over secure channels. You must set a service-level password in order to access camera functions. Web browser and viewing client access can be protected using HTTPS or other secure protocols that support state-of-the-art TLS 1.2 protocol with updated cipher suites, including AES encryption with 256 bit keys. No software can be installed in the camera, and only authenticated firmware can be uploaded. A three-level password protection with security recommendations allows users to customize device access. Network and device access can be protected using 802.1x network authentication with EAP/TLS protocol. Superior protection from malicious attacks is guaranteed by the Embedded Login Firewall, on-board Trusted Platform Module (TPM) and Public Key Infrastructure (PKI) support.

The advanced certificate handling offers:

- Self-signed unique certificates automatically created when required.
- Client and server certificates for authentication.
- Client certificates for proof of authenticity.
- Certificates with encrypted private keys.

Software sealing

After camera configuration is set it should not be changed, and system administrators can enable software protection to seal the camera configuration. Any change of the sealing status or of the static configuration, accidental or intentional, will break the seal. The camera then sends an alarm message that the video management system can use to start an appropriate alarm scenario. The camera creates a separate log file of all changes that have an effect on the sealing status.

System integration and ONVIF conformance

The camera conforms to the ONVIF Profile S, ONVIF Profile G and ONVIF Profile T specifications. For H.265 configuration, the camera supports Media Service 2, which is part of ONVIF Profile T. Compliance with these standards guarantees interoperability between network video products regardless of manufacturer. Third-party integrators can easily access the internal feature set of the camera for integration into large projects. Visit the Bosch Integration Partner Program (IPP) website (ipp.boschsecurity.com) for more information.

PTZ drive and mechanism

The camera supports 256 pre-positions and two styles of Guard Tours: Pre-position and Record/Playback. The Pre-position tour has capability for up to 256 pre-positions with a configurable dwell time between pre-positions and can be customized as to the order and the frequency that each Pre-position is visited. The camera also provides support for two (2) recorded tours, which have a total duration of 15 minutes of movements. These are recorded macros of an operator's movements, including pan, tilt, and zoom activities, and can be played back in a continuous manner.

Pan and tilt preset repeatability are accurate to within ± 0.1 degrees to ensure that the correct scene is captured every time. The camera delivers maximum pan speed of 300 degrees per second and maximum tilt speed of 200 degrees per second. The camera is capable of manual speeds (pan and tilt) of 0.1 to 120 degrees per second. The camera provides a pan range of up to 360 degrees continuous rotation.

Ease of installation and servicing

The camera has been designed for quick and easy installation, a key feature from Bosch IP video products. All housings feature recessed screws and latches for increased tamper resistance. Bosch designed the camera with the knowledge that field cables and mounts are installed before the camera is mounted. The installation concept allows a single person to connect the cables directly to the camera without re-routing cables. The camera is easily secured to the mount with 1 screw.

The pendant housing is rated to provide IP66 protection and offers an operating temperature range down to -40°C (-40°F). The pendant camera comes fully assembled with a sunshield and ready for pendant arm or pipe applications with the proper mounting hardware (sold separately).

Bosch offers a full complement of hardware and accessories (sold separately) for wall, corner, mast, roof, pipe mount, and in-ceiling applications for indoor and outdoor environments, which allow the camera to be adapted easily to individual site requirements.

Project Assistant

Project Assistant by Bosch is the market's most easy-to-use app for initial installation and basic configuration of IP cameras. Off-site and without

connection to the camera, basic configurations can be created and then shared with colleagues. On-site, these pre-configurations can be pushed onto the camera, making the installation procedure easier and less time-consuming. Cameras previously configured can be integrated as well. The app allows easy viewing and adjustment of the camera's field of view. The app automatically generates a comprehensive report of the commissioned cameras.

Certifications and approvals

For a full list of all related certifications/standards, refer to the Product Tests Report, available on the online catalog, on the Documents tab of the product page for your device. If the document is unavailable on the product page, contact your sales representative.

Electromagnetic Compatibility (EMC)	FCC Part 15, ICES-003 EN 55032:2015/AC:2016 EN 50130-4:2011 EN 61000-3-2:2014 EN 61000-3-3:2013 EN 50121-4
Product Safety	Complies with UL, CE, CSA, EN, and IEC standards including: UL 62368-1 EN 62368-1 EN 60950-1 CAN/CSA-C22.2 No. 62368-1-14 IEC 62368-1 Ed.2 IEC 60950-1 Ed.2 IEC 60950-22 Ed.2
Marks	UL, CE, WEEE, RCM, EAC, VCCI, FCC, RoHS, CMIM, BIS*

Note: Some marks are available for specified models only.

Region	Regulatory compliance/quality marks	
Europe	CE	Declaration of Conformity (DoC) - AUTODOME IP starlight 5100i, -IR

Installation/configuration notes

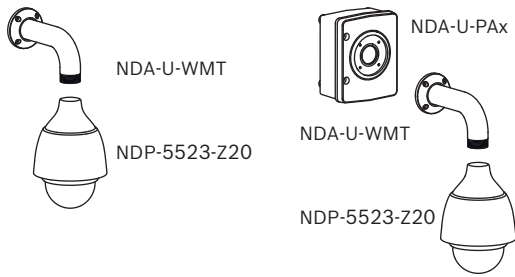

Fig. 1: Wall mount; Wall mount with surveillance cabinet (IP66)

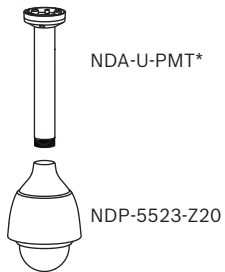

Fig. 2: Pendant pipe mount
*NDA-U-PMTE: optional 50 cm/20 inches extension pipe

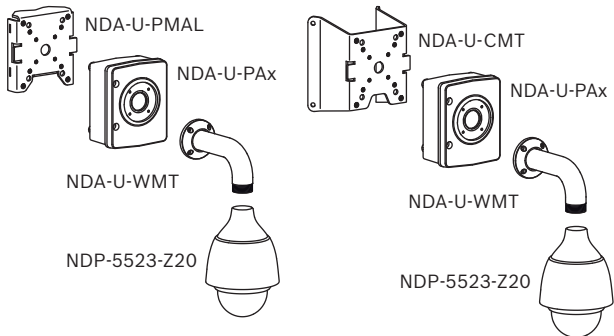

Fig. 3: Pole mount (IP66); Corner mount (IP66)

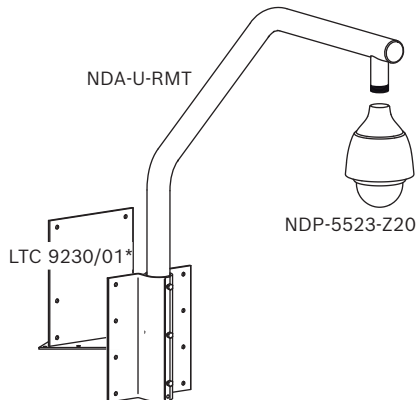

Fig. 4: Roof mount (IP66)
*Optional for flat roof mount

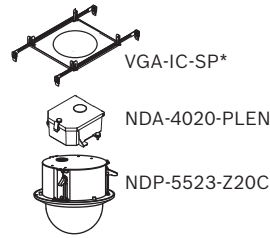

Fig. 5: In-ceiling mount
*Optional

For more options, see [Quick Selection Guide: Modular camera mounts & accessories.](#)

Dimensional Drawings

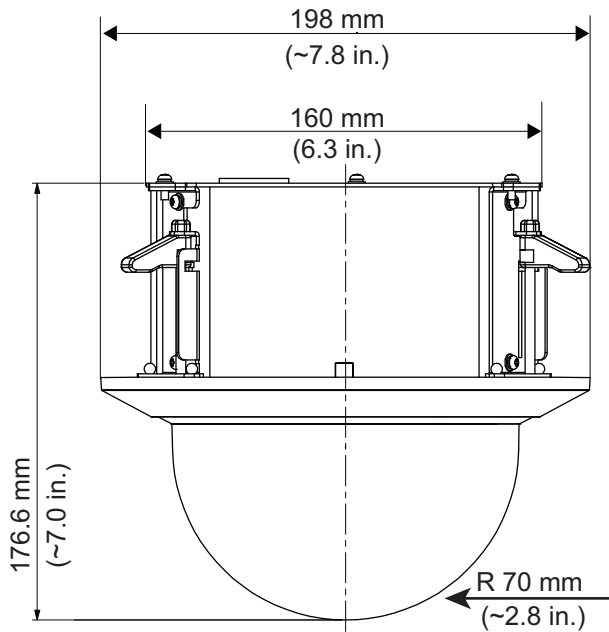

Fig. 6: In-ceiling model

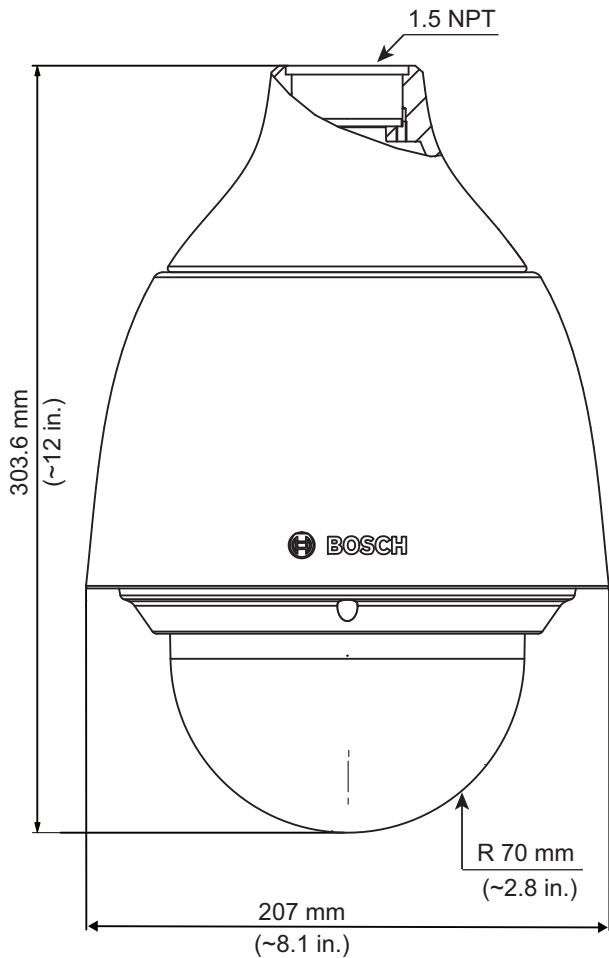

Fig. 7: Pendant model

Technical specifications

Imager	1/1.8 inch CMOS
Effective picture elements	2688 x 1520 (4 MP)
Lens	20x motorized zoom 6.5 mm - 130 mm (F1.55 - F3.95)
Optical zoom Field of view (FOV)	3.5° to 61.1°
Focus	Automatic with manual override
Iris	Automatic with iris priority feature
Digital zoom	16x
Video sensitivity	3100K, reflectivity 89%, 1/30, F1.55, 30 IRE
Minimum illumination in color (lx)	0.0107 lux
Minimum illumination in monochrome (lx)	0.0016 lux
High dynamic range	133 dB WDR
Measured according to IEC 62676 Part 5	107 dB WDR
Gain control	AGC, Variable 6 dB to 78 dB
Electronic Shutter Speed (AES)	0.64 sec to 1/66666 sec
Signal-to-Noise Ratio (SNR)	>55 dB
Day/Night switch	Automatic IR cut filter
Backlight compensation (BLC)	On, Off, Intelligent Auto Exposure (IAE)
White balance	Basic auto, Standard auto, Sodium lamp auto, Dominant color auto, Manual
Day/Night (mode)	Monochrome, Color, Auto
Defog mode feature	Improves visibility when viewing foggy or other low-contrast scenes.
Sector/Titling	16 independent sectors with 20 characters per title
Privacy Masks	32 individually configurable privacy masks
Privacy Masks pattern	Black, White, Gray, Auto (average background color)

Supported Languages	English, German, Spanish, French, Italian, Dutch, Polish, Portuguese, Russian, Japanese, Chinese (simplified)
Video Content Analysis	
Analysis type	Essential Video Analytics
Configurations	Silent VCA / Profile 1/2 / Scheduled / Event triggered
Alarm rules (combinable)	Any object Object in field Line crossing Enter / leave field Loitering Follow route Idle / removed object Counting Occupancy Crowd density estimation Condition change Similarity search
Object filters	Duration Size Aspect ratio Speed Direction Color Object classes (4)
Calibration / Geolocation	Accelerometer data and camera height
Tamper detection	Maskable
Detection	Audio
Mechanical	
Pan/Tilt modes	Normal: 0.1°/s - 120°/s Turbo: Pan: 0.1°/s - 300°/s; Tilt: 0.1°/s - 200°/s
Pre-position speed	Pan: 300°/s Tilt: 200°/s
Pan Range	360° continuous
Tilt Angle	-90° to 0° (Auto-flip 180°)
Pre-position Accuracy	± 0.1° typ.
Pre-positions	256

Tours	Recorded tours: two (2), maximum total duration 15 minutes (depending on the amount of commands sent during recording) Pre-position tour: one (1), consisting of up to 256 scenes consecutively, and one (1), customized up to 64 scenes
-------	---

Electrical

Power source	24 VAC PoE+ (IEEE 802.3at, class 4 standard)
Power consumption (in-ceiling)	14.4 W / 25.2VAC
Power consumption (pendant) (standard operation, with heater OFF)	14.4 W / 25.2VAC
Power consumption (pendant) (maximum, with heater ON)	20.1 W / 31.2VAC

Network

Ethernet	10/100BASE-T
Encryption	TLS 1.2, SSL, DES, 3DES, AES
Protocols	IPv4, IPv6, UDP, TCP, HTTP, HTTPS, RTP/RTCP, IGMP V2/V3, ICMP, ICMPv6, RTSP, FTP, ARP, DHCP, APIPA (Auto-IP, link local address), NTP (SNTP), SNMP (V1, V3, MIB-II), 802.1x, DNS, DNSv6, DDNS (DynDNS.org, selfHOST.de, no-ip.com), SMTP, iSCSI, UPnP (SSDP), DiffServ (QoS), LLDP, SOAP, Dropbox™, CHAP, digest authentication
Interoperability	ONVIF Profile S, ONVIF Profile G, ONVIF Profile T, GB/T 28181

Video compression	H.265 H.264 M-JPEG
Streaming	Four (4) streams: Two (2) configurable streams in H.264 or H.265 One (1) I-frame-only stream based on first stream One (1) M-JPEG Stream
Maximum frame rate	60fps at all resolutions
IP delay (typical)	60 fps: 200 ms

Resolution

1440p	2560 x 1440
-------	-------------

1080p HD	1920 x 1080
720p HD	1280 x 720
1.3 MP 5:4 (cropped)	1280 x 1024
D1 4:3 (cropped)	704 x 576
640 x 480	640 x 489
432p SD	768 x 432
288p SD	512 x 288
144p SD	256 x 144

Bitrate 2560 x 1440

FPS	H.264	H.265
60	8980	6720
30	5480	4120
25	4820	3620
15	3380	2520
8	2180	1640
4	1340	1000
2	840	620
1	520	380

Actual bitrate may vary depending on the pictures settings of the scene and on encoding configurations.

Local Storage

Memory card slot	Support a memory card with a maximum of 32 GB (microSDHC) / 2 TB (microSDXC) (user-supplied). (An SD card of Class 6 or higher is recommended for HD recording.)
------------------	--

User Connections

Power	RJ45 10/100 Base-T PoE+ (IEEE 802.3at, class 4 standard) 21-30 VAC, 50/60 Hz
Alarm Inputs	2
Alarm Outputs	1 relay output 5 VDC, 150 mA maximum
Audio	1x mono line in, 1x mono line out
Signal line in	94 kOhm typical, 1 Vrms maximum
Signal line out	1 kOhm typical, 1 Vrms maximum

Audio

Compression	G.711, 8kHz sampling rate L16, 16kHz sampling rate AAC, 16kHz sampling rate
Interface	1/1 Channel In/Out

Environmental (in-ceiling model)

Operating temperature	-10 °C to +60 °C (+14 °F to +140 °F)
Humidity	Up to 90% RH, non-condensing
Storage temperature	-40 °C to +60 °C (-40 °F to +140 °F)

Ingress Protection Rating/ Standard	IP51
-------------------------------------	------

Environmental (pendant model)

Operating temperature	-40 °C to +60 °C (-40 °F to +140 °F)
Humidity	0% to 100% RH, condensing
Storage temperature	-40 °C to +60 °C (-40 °F to +140 °F)

Ingress Protection Rating/ Standard	IP66
-------------------------------------	------

IK Rating	IK10
-----------	------

Construction (in-ceiling model)

Dimensions (DIA x H)	198 mm x 176.6 mm (7.8 in x 6.95 in)
Weight	2.1 kg (4.63 lb)
Construction material	Housing: SPCC Trim ring: PC/ABS Bubble: Polycarbonate
Standard color	White (RAL 9003)

Construction (pendant model)

Dimensions (D x H)	207 mm x 303.6 mm (8.15 in x 11.95 in)
Weight	3.25 kg (7.17 lb)
Construction Material	Housing: Aluminum Sunshield: Outdoor Grade Plastic Bubble: Polycarbonate, anti-reflective, anti-static, anti-scratch, hydrophobic, UV protective

Standard Color	White (RAL 9003)
----------------	------------------

Ordering information

NDP-5523-Z20 PTZ 4MP HDR 20x clear IP66 pendant
PTZ dome camera, 4MP HDR, 20x optical zoom, clear, IP66 pendant

Available in specific regions only.

Order number **NDP-5523-Z20 | F.01U.359.949**

NDP-5523-Z20C PTZ 4MP HDR 20x clear in-ceiling
PTZ dome camera, 4MP HDR, 20x optical zoom, clear, indoor in-ceiling

Available in specific regions only.

Order number **NDP-5523-Z20C | F.01U.359.950**

NDP-5523-Z20-P PTZ 4MP HDR 20x clear IP66 pendant
PTZ dome camera, 4MP HDR, 20x optical zoom, clear, IP66 pendant

NDAA compliant

Order number **NDP-5523-Z20-P | F.01U.385.088**

NDP-5523-Z20C-P PTZ 4MP HDR 20x clear in-ceiling
PTZ dome camera, 4MP HDR, 20x optical zoom, clear, indoor in-ceiling

NDAA compliant

Order number **NDP-5523-Z20C-P | F.01U.385.089**

Accessories

UPA-2450-50 PSU, 220VAC 50Hz, 24VAC 50VA out

Indoor power supply for camera. 220 VAC, 50 Hz in; 24 VAC, 50 VA out

Order number **UPA-2450-50 | F.01U.076.157**

UPA-2450-60 PSU, 120VAC 60Hz, 24VAC 50VA out

Indoor power supply for camera. 120 VAC, 60 Hz In; 24 VAC, 50 VA Out

Order number **UPA-2450-60 | F.01U.076.154**

NPD-6001B Midspan, 60W, single port, AC in

60 W indoor midspan for cameras without illuminators

Order number **NPD-6001B | F.01U.347.358**

F.01U.392.458

NDA-U-PA0 Surveillance cabinet 24VAC

Surveillance cabinet, 24 VAC input, 24 VAC output, IP66

Order number **NDA-U-PA0 | F.01U.324.947**

NDA-U-PA1 Surveillance cabinet 120VAC

Surveillance cabinet, 100 - 120 VAC 50/60 Hz input, 24 VAC output, IP66

Order number **NDA-U-PA1 | F.01U.324.948**

NDA-U-PA2 Surveillance cabinet 230VAC

Surveillance cabinet, 230 VAC input, 24 VAC output, IP66

Order number **NDA-U-PA2 | F.01U.324.949**

NDA-U-WMT Pendant wall mount

Universal wall mount for dome cameras, white

Order number **NDA-U-WMT | F.01U.324.939**

NDA-U-PMT Pendant pipe mount, 12" (31cm)

Universal pipe mount for dome cameras, 31 cm, white

Order number **NDA-U-PMT | F.01U.324.940**

NDA-U-PMTE Pendant pipe extension, 20" (50cm)

Extension for universal pipe mount, 50 cm, white

Order number **NDA-U-PMTE | F.01U.324.941**

NDA-U-PMTS Pendant pipe mount, 4" (11 cm)

Universal pendant pipe mount for dome cameras, 11 cm (4"), white

Order number **NDA-U-PMTS | F.01U.385.046**

NDA-U-PSMB Pendant wall/ceiling mount SMB

Surface mount box (SMB) for wall mount or pipe mount.

Order number **NDA-U-PSMB | F.01U.324.942**

VGA-IC-SP Suspended ceiling support kit,7"

Suspended ceiling support kit for dome cameras.

Aperture Ø177 mm (Ø7 in). Maximum supported weight 11.3 kg (25 lb).

Order number **VGA-IC-SP | F.01U.245.271**

NDA-U-WMP Wall mount plate

Back plate for universal wall mount, corner mount and pole mount, white, IP66

Order number **NDA-U-WMP | F.01U.324.950**

NDA-U-CMT Corner mount adapter

Universal corner mount, white

Order number **NDA-U-CMT | F.01U.324.946**

NDA-U-PMAL Pole mount adapter large

Universal pole mount adapter, white; large

Order number **NDA-U-PMAL | F.01U.324.944**

NDA-U-RMT Pendant parapet mount

Universal roof mount for dome cameras, white

Order number **NDA-U-RMT | F.01U.324.945**

NDA-5020-PTBL Tinted bubble for PTZ dome

Tinted bubble for pendant models of AUTODOME IP 5000i cameras.

Order number **NDA-5020-PTBL | F.01U.396.550**

F.01U.332.331

NEZ-A5-BUB-CTIP Bubble, tinted, for in-ceiling model

Tinted bubble for in-ceiling models of AUTODOME IP 5000i cameras.

Order number **NEZ-A5-BUB-CTIP | F.01U.396.552**

F.01U.313.102

Services

EWE-AD5HD-IW 12mths wrty ext AUTODOME IP 5000 HD

12 months warranty extension without moving parts, wear parts are excluded

Order number **EWE-AD5HD-IW | F.01U.346.303**

Represented by:

Europe, Middle East, Africa:
Bosch Security Systems B.V.
P.O. Box 80002
5600 JB Eindhoven, The Netherlands
Phone: + 31 40 2577 284
emea.securitysystems@bosch.com
emea.boschsecurity.com

Germany:
Bosch Sicherheitssysteme GmbH
Robert-Bosch-Ring 5
85630 Grasbrunn
Germany
www.boschsecurity.com

North America:
Bosch Security Systems, LLC
130 Perinton Parkway
Fairport, New York, 14450, USA
Phone: +1 800 289 0096
Fax: +1 585 223 9180
onlinehelp@us.bosch.com
www.boschsecurity.us

Asia-Pacific:
Robert Bosch (SEA) Pte Ltd, Security Systems
11 Bishan Street 21
Singapore 573943
Phone: +65 6571 2808
Fax: +65 6571 2699
apr.securitysystems@bosch.com
www.boschsecurity.asia